

USER MANUAL

MODEL:

KIT-401

4K Auto-Switcher/Scaler Kit



Contents

Introduction	1
Getting Started	1
Overview	2
Typical Applications	4
Defining KIT-401 4K Auto-Switcher/Scaler Kit	5
Defining KIT-401T	5
Defining KIT-400R	7
Mounting KIT-401	8
Mounting KIT-401T	8
Mounting KIT-400R	9
Connecting KIT-401	10
Connecting the Output to a Balanced/Unbalanced Stereo Audio Acceptor	11
Connecting to KIT-401 via RS-232	11
Connecting an Occupancy Sensor to the TOGL Pin	12
Wiring RJ-45 Connectors	12
Operating and Controlling KIT-401	13
Using Front Panel Buttons	13
Using Remote Control Switches	13
Setting KIT-401T DIP-switches	14
Tunneling RS-232 data between KIT-401T and KIT-400R	14
Using the OSD Menu on KIT-400R	17
Operating via Ethernet	26
Using Embedded Webpages	29
Browsing Webpages	29
Switching and adjusting Port Signals	31
Defining General settings	32
Configuring Network Settings	34
Defining Time and Date	36
Upgrading the Firmware	37
Setting Authentication	39
Defining Video and Audio Settings	41
Defining Receiver Settings	43
Configuring Device Automation	44
Operating via Room Automation Panel	47
Managing EDID	60
Viewing About Page	66
Upgrading Firmware	67
Upgrading KIT-401T	67
Upgrading KIT-400R	67
Technical Specifications	68
Default Communication Parameters	70
KIT-400R Output Resolution Support	70
Default EDID	70
Protocol 3000	77
Understanding Protocol 3000	77
Protocol 3000 Commands	78
Result and Error Codes	94

Introduction

Welcome to Kramer Electronics! Since 1981, Kramer Electronics has been providing a world of unique, creative, and affordable solutions to the vast range of problems that confront the video, audio, presentation, and broadcasting professional on a daily basis. In recent years, we have redesigned and upgraded most of our line, making the best even better!

Getting Started

We recommend that you:

- Unpack the equipment carefully and save the original box and packaging materials for possible future shipment.
- Review the contents of this user manual.



Go to www.kramerav.com/downloads/KIT-401 to check for up-to-date user manuals, application programs, and to check if firmware upgrades are available (where appropriate).

Achieving Best Performance

- Use only good quality connection cables (we recommend Kramer high-performance, high-resolution cables) to avoid interference, deterioration in signal quality due to poor matching, and elevated noise levels (often associated with low quality cables).
- Do not secure the cables in tight bundles or roll the slack into tight coils.
- Avoid interference from neighboring electrical appliances that may adversely influence signal quality.
- Position your Kramer **KIT-401** away from moisture, excessive sunlight and dust.

Safety Instructions



Caution:

- This equipment is to be used only inside a building. It may only be connected to other equipment that is installed inside a building.
- For products with relay terminals and GPIO ports, please refer to the permitted rating for an external connection, located next to the terminal or in the User Manual.
- There are no operator serviceable parts inside the unit.



Warning:

- Use only the power cord that is supplied with the unit.
- To ensure continuous risk protection, replace fuses only according to the rating specified on the product label which is located on the bottom of the unit.

Recycling Kramer Products

The Waste Electrical and Electronic Equipment (WEEE) Directive 2002/96/EC aims to reduce the amount of WEEE sent for disposal to landfill or incineration by requiring it to be collected and recycled. To comply with the WEEE Directive, Kramer Electronics has made arrangements with the European Advanced Recycling Network (EARN) and will cover any costs of treatment, recycling and recovery of waste Kramer Electronics branded equipment on arrival at the EARN facility. For details of Kramer's recycling arrangements in your particular country go to our recycling pages at www.kramerav.com/il/quality/environment.

Overview

Congratulations on purchasing your Kramer **KIT-401 4K Auto-Switcher/Scaler Kit**.

KIT-401 is a high-performance auto-switcher/scaler kit for 4K HDMI™ and VGA over long-reach HDBaseT. The kit includes the **KIT-401T** wall-plate transmitter/switcher and the **KIT-400R** receiver/scaler. The **KIT-401T** transmitter converts the user-selected input signal into the transmitted HDBaseT signal. **KIT-400R** receiver receives the HDBaseT signal, converts it to HDMI and up- or down-scales the picture to match the resolution of the HDMI monitor. **KIT-401** extends video signals to up to 40m (130ft) over CAT copper cables at up to 4K@60Hz (4:2:0) 24bpp video resolution and provides even further reach for lower HD video resolutions.

KIT-401 provides exceptional quality, advanced and user-friendly operation, and flexible control.

Exceptional Quality

- HDMI Signal Extension – HDCP 1.4 / 2.2. 4K60, CEC, xvYCC color (on input).
- EDIDPro™ Kramer Intelligent EDID Processing™ – Intelligent EDID handling, processing and pass-through algorithm that ensures Plug and Play operation.

Advanced and User-friendly Operation

- Automatic Room Control – Supports connection to an occupancy sensor and remote switches, and includes a relay for driving room peripherals.
- Automatic Display Control – Supports CEC that enables automatically turning the display on and off.
- Simple and Powerful Maestro Room Automation – Intuitive user interface enables you to fully automate your meeting room elements. Configure lights, shades, devices and more to be activated by an extensive range of triggers, including scheduling, input/output connectivity, routing, and button pressing. By minimizing user intervention, Maestro room automation saves meeting prep time and minimizes human error before presentations.
- PoC (Power over Cable) – Power only one of the units. The other unit is powered via the HDBaseT cable linking the receiver/transmitter pair.

- Easy Remote Device Control – Control devices connected to **KIT-401** from the user-friendly Kramer Aware interface on the **KIT-401** embedded webpages and access the interface using the Kramer Aware app on a compatible Kramer touch panel.
- Convenient Unit Control and Configuration Options – Local control via front panel source and output switching buttons (on **KIT-400R**), DIP-switches for configuring audio connection priority, and OSD menu. Distance control via user-friendly embedded webpages via Ethernet, Protocol 3000 API, RS-232 serial commands transmitted by a PC, touch screen system or other serial controller and relay switches.
- Bidirectional RS-232 Extension – Serial interface data flows in both directions, allowing data transmission and device control.
- Auto-scanning of inputs.
- Efficient power-saving features.
- Field Upgradable – Via its USB port (**KIT-401T** and **KIT-400R**), or via Ethernet (**KIT-401T**).
- Easy, Cost-effective Maintenance – Local firmware upgrade via USB connector.
- Easy and Elegant Installation – Installation is fast and cost-effective via a single CAT cable, providing both video signal and power (PoC) connections. The transmitter compactly fits into standard US, EU and UK 2 gang in-wall box size, supporting decorative integration with room deployed user interfaces such as electrical switches. The compact MegaTOOLS™ fan-less receiver enclosure for dropped-ceiling mounting, or side-by-side mounting of 2 units in a 1U rack space with the recommended rack adapter.

Flexible Connectivity

- Local Switching Control of 2 Local and 1 Remote Source – With auto-switching of the live source to the HDMI display on the output at the receiver. The transmitter has an HDMI and a VGA input, with a dedicated audio jack, and there is an additional HDMI input on the receiver side.
- Audio De-embedding – Output the HDMI audio to a balanced stereo output on the receiver side, and an unbalanced stereo output on the transmitter side.

Typical Applications

KIT-401 is ideal for the following typical applications:

- Classrooms and lecture halls.
- Meeting rooms.
- Training facilities.
- Collaborative classrooms.
- Any space where BYOD support is required.

Controlling your KIT-401

Control your KIT-401 via:

- Navigation buttons to access the OSD menu on **KIT-400R**.
- RS-232 serial commands transmitted by a touch screen system, PC, or other serial.
- The Ethernet using built-in user-friendly webpages.
- Kramer Aware app from a compatible Kramer touch panel.

Defining KIT-401 4K Auto-Switcher/Scaler Kit

This section defines KIT-401T and KIT-400R.

Defining KIT-401T

EU + UK

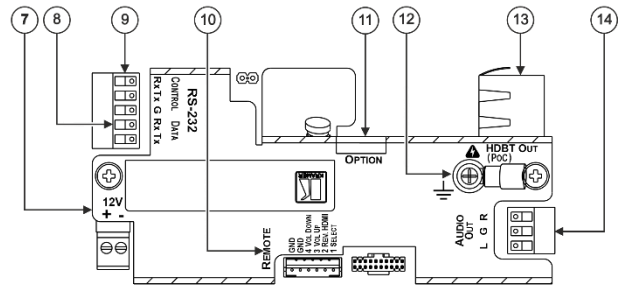
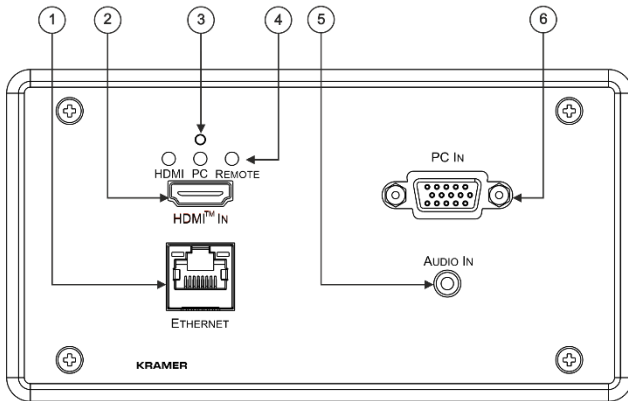

US

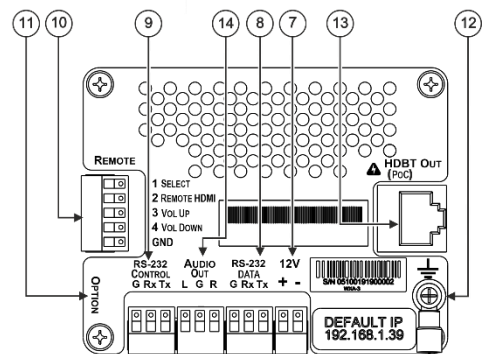
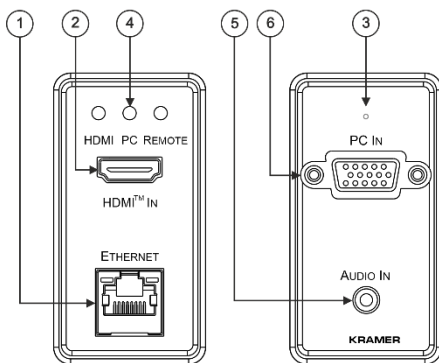



Figure 1: KIT-401T 4K HDMI/PC Auto Switcher Transmitter

#	Feature	Function	
①	ETHERNET LAN RJ-45 Connector	Connect to the LAN (Ethernet traffic or PC controller).	
②	HDMI™ IN Connector	Connect to an HDMI source.	
③	RESET Button	Located behind the faceplate. Sends a reset command to KIT-400R and then reboots KIT-401T .	
④	HDMI	LED Indicator	Lights green when the HDMI source is selected as the input. Lights red when analog audio is selected.
	PC		Lights green when the PC source is selected as the input. Lights red when analog audio is selected.
	REMOTE		Lights green when the HDMI INPUT source on KIT-400R is selected as the input.
⑤	AUDIO IN 3.5mm Mini Jack	Connect to an unbalanced, stereo audio source (for example, the audio output of the laptop).	
⑥	PC 15-pin HD Connector	Connect to a PC graphics source.	

#	Feature	Function
⑦	12V Power Supply 2-pin Terminal Block Connector	Connect to the supplied power adapter (if required). Connect + to +, - to -.  Connect power to either this terminal block or to the KIT-400R 12V power connector (item 34). Do not connect to both!
⑧	RS-232 DATA 3-pin Terminal Block Connector	Connect to a serial data source or acceptor.
⑨	CONTROL 3-pin Terminal Block Connector	Connect to a serial controller or PC.
⑩	Remote Contact-closure 4-pin Terminal Block Connector	Connect to contact closure switches (by momentary contact between the desired pin and GND pin) to select an input, the remote HDMI IN and audio volume (up or down), see Using Remote Control Switches on page 13.
⑪	OPTION 4-way DIP-switch	Set the device behavior (see Setting KIT-401T DIP-switches on page 14).
⑫	Ring Tongue Terminal Grounding Screw	Connect to grounding wire (optional).
⑬	HDBT OUT (PoC) RJ-45 Connector	Connect to KIT-400R .
⑭	AUDIO OUT 3.5mm Mini Jack	Connect to the unbalanced, stereo audio acceptor (for example, active speakers).

Defining KIT-400R

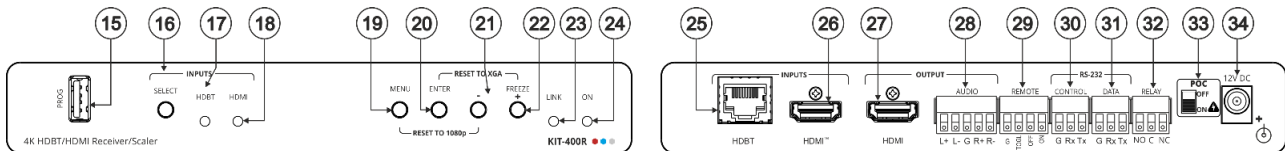



Figure 2: KIT-400R 4K HDBT/HDMI Receiver/Scaler

#	Feature	Function	
15	PROG USB Connector	Connect to a USB stick to perform firmware upgrades.	
16	INPUTS	SELECT Button	Press to select the input (HDBT or HDMI). <i>i</i> By default, the SELECT button is locked. You can unlock it via the ADVANCED menu in the OSD (see Locking KIT-400R Input Buttons on page 19).
17		HDBT LED	Lights blue when the HDBT input is selected.
18		HDMI LED	Lights blue when the HDMI input is selected.
19	MENU Button	Press to enter/exit the on-screen display (OSD) menu. Press together with the – button to reset to 1080p.	
20	ENTER Button	In OSD, press to choose the highlighted menu item. Press together with the FREEZE/+ button to reset to XGA.	
21	–	In OSD, press to move back through menus or decrement parameter values.	
22	FREEZE/+ Button	In OSD, press to move forward through menus or increment parameter values. When not in OSD, press to freeze the display.	
23	LINK LED	Lights blue when a link is established with the transmitter.	
24	ON LED	Lights green when device is powered.	
25	INPUTS	HDBT RJ-45 Connector	Connect to KIT-401T .
26		HDMI Connector	Connect to an HDMI source.
27	OUTPUT	HDMI Connector	Connect to an HDMI acceptor.
28		AUDIO 5-pin Terminal Block Connector	Connect to a balanced stereo audio acceptor.
29	REMOTE Contact-Closure 4-pin Terminal Block Connector	Connect to contact closure switches, an occupancy sensor and/or toggle switches (contact between the desired pin and GND pin), to turn the display on or off. (See Using Remote Control Switches on page 13).	
30	RS-232	CONTROL 3-pin Terminal Block Connector	Connect to a serial controller or PC.
31		DATA 3-pin Terminal Block Connector	Connect to a serial data source or acceptor.
32	RELAY 3-pin Terminal Block Connector	Connections to the internal relay: Normally open (NO), normally closed (NC), and common (C). Connect to devices to be controlled by relay (for example, a motorized projection screen).	
 Follow powering instructions in (see Connecting KIT-401 on page 10). Failure to use PoC and power connector correctly may destroy the devices!			
33	PoC (Power Over Cable) Switch	Set the PoC switch to ON on KIT-400R .	
34	12V DC Connector	Connect to the supplied power adapter unless the power adapter is connected to KIT-401T .	

Mounting KIT-401

KIT-401 includes the KIT-401T wall-plate and the KIT-400R TOOL. This section describes:

- [Mounting KIT-401T](#) on page [8](#).
- [Mounting KIT-400R](#) on page [9](#).

Mounting KIT-401T



Before mounting the KIT-401T you need to connect the HDBT cable (and power – if powering via the transmitter).

Insert the device into the in-wall box, and connect the parts as shown in the illustrations below:

EU/UK Version

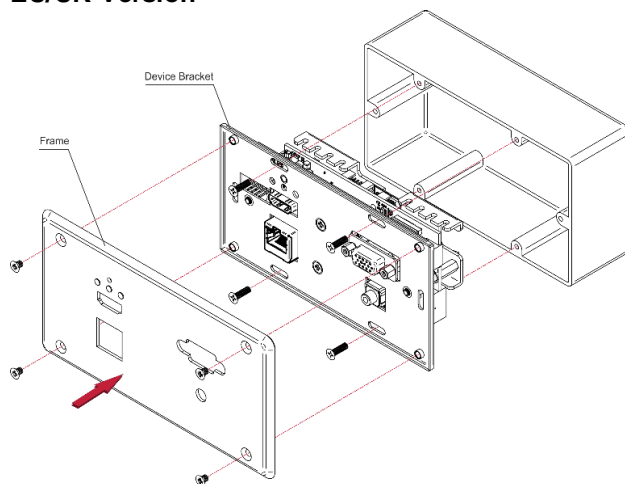

US-D Version

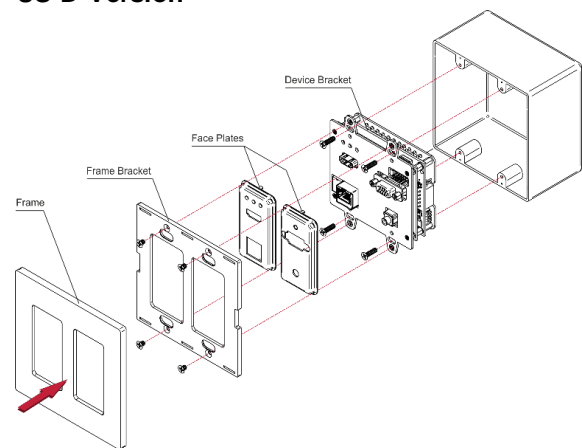

DECORA® design frames are included in US-D models.

DECORA® is a registered trademark of Leviton Manufacturing Co., Inc.

We recommend that you use any of the following standard 2 gang in-wall junction boxes (or their equivalent):

- **US-D:** 2 gang US electrical junction boxes.
- **EU:** 2 gang in-wall junction box, with a cut-hole diameter of 2x68mm and depth that can fit in both the device and the connected cables (DIN 49073).
- **UK:** 2 gang in-wall junction box (BS 4662), 135x75mm (W, H) and depth that can fit in both the device and the connected cables.
- **EU/UK:** 2 gang on-wall junction box (use the recommended Kramer on-wall box available at www.kramerav.com/product/KIT-401T).

Mounting KIT-400R

This section provides instructions for mounting **KIT-401**. Before installing, verify that the environment is within the recommended range:



- Operation temperature – 0° to 40°C (32 to 104°F).
- Storage temperature – -40° to +70°C (-40 to +158°F).
- Humidity – 10% to 90%, RHL non-condensing.



Caution:

- Mount **KIT-401** before connecting any cables or power.



Warning:

- Ensure that the environment (e.g., maximum ambient temperature & air flow) is compatible for the device.
- Avoid uneven mechanical loading.
- Appropriate consideration of equipment nameplate ratings should be used for avoiding overloading of the circuits.
- Reliable earthing of rack-mounted equipment should be maintained.
- Maximum mounting height for the device is 2 meters.

Mount KIT-401 in a rack:

- Use the recommended rack adapter (see www.kramerav.com/product/KIT-401).

Mount KIT-401 on a surface using one of the following methods:

- Attach the rubber feet and place the unit on a flat surface.
- Fasten a bracket (included) on each side of the unit and attach it to a flat surface. For more information go to www.kramerav.com/downloads/KIT-401.

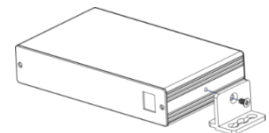

Connecting KIT-401



Always switch off the power to each device before connecting it to your **KIT-401**. After connecting your **KIT-401**, connect its power and then switch on the power to each device.

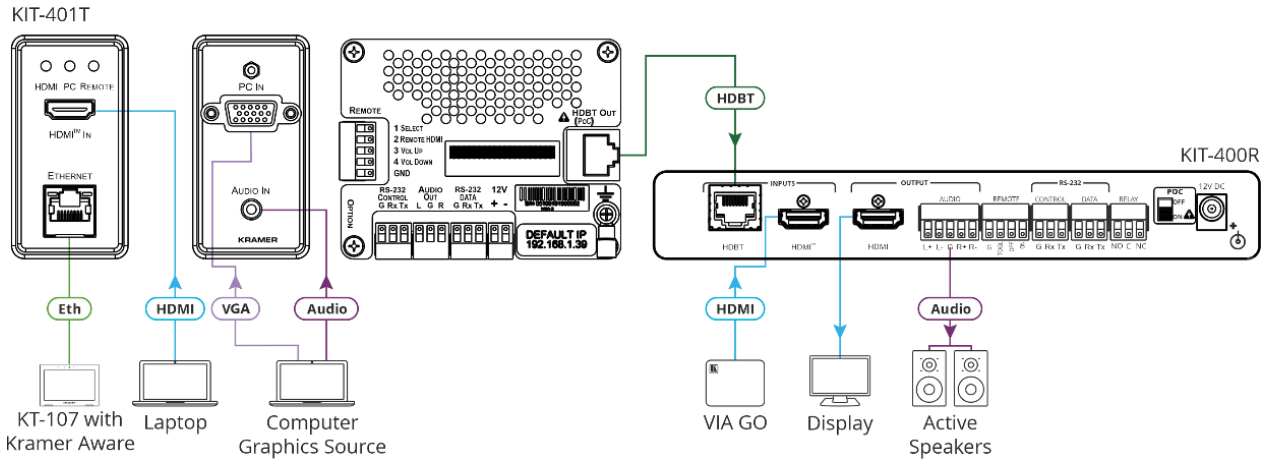

Figure 3: Connecting to the KIT-401

To connect KIT-401 as illustrated in the example in Figure 3:

- Before Installing the wall plate (see [Mounting KIT-401T](#) on page 8):
 - Connect the HDBT OUT RJ-45 port (13) on the **KIT-401T** rear panel to the HDBT INPUT RJ-45 port (25) on the **KIT-400R**.
 - If powering **KIT-401** via the **KIT-401T**, connect the power adapter to **KIT-401T**.
- Connect a source to the transmitter:
 - Connect an HDMI source (for example, a laptop) to the HDMI IN connector (2) on the **KIT-401T** front panel.
 - Connect a computer graphics source (for example, a PC) to the PC IN 15-pin HD connector (6) and an unbalanced audio source (for example, the PC audio output) to the AUDIO IN 3.5mm mini jack (5) on the **KIT-401T** front panel.



Although both sources may be connected simultaneously, in most applications only one source would be plugged in. Typically, the user comes to the podium (for example, when the **KIT-401T** is mounted on a podium) and plugs in his/her own laptop to present.

- Connect a control device (for example, **KT-107** with Kramer Aware App) to the ETHERNET RJ-45 port (1) on the **KIT-401T** front panel.
- Connect an HDMI source (for example, Kramer **VIA GO**) to the HDMI INPUT connector (26) on the **KIT-400R**.
- Connect the HDMI OUTPUT connector (27) on the **KIT-400R** to an HDMI acceptor (for example, a display).
- Connect the AUDIO OUTPUT 5-pin terminal block connector (28) on the **KIT-400R** to a balanced stereo audio source (for example, Kramer active speakers).

7. Set POC switch on **KIT-400R** (33) to ON.



Failure to use PoC and power connector correctly may destroy the devices!

8. Connect the power adapter to one of the devices (**KIT-401T** or **KIT-400R**) and to the mains electricity (not shown in [Figure 3](#)).

Connecting the Output to a Balanced/Unbalanced Stereo Audio Acceptor

The following are the pinouts for connecting the output to a balanced or unbalanced stereo audio acceptor:

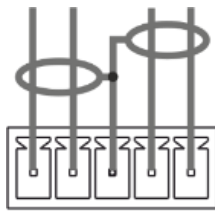

L+ L- G R+ R-

Figure 4: Connecting to a Balanced Stereo Audio Acceptor

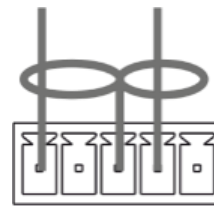

L+ L- G R+ R-

Figure 5: Connecting to an Unbalanced Stereo Audio Acceptor

Connecting to KIT-401 via RS-232

You can connect to the **KIT-401** via an RS-232 connection using, for example, a PC.

KIT-401 features two RS-232 3-pin terminal block connectors:

- CONTROL (9) - To control **KIT-401** (for example, via a connected PC).
- CONTROL (30) – To control **KIT-400R** (for example, via a connected PC).
- DATA ((8) for **KIT-401T** and (31) **KIT-400R**) – To tunnel RS-232 data between the transmitter and the receiver, see [Tunneling RS-232 data between KIT-401T and KIT-400R](#) on page 14, (for example, to control the projector via RS-232 using a controller at the transmitter side).

Connect the RS-232 terminal block on the rear panel of the **KIT-401** to a PC/controller, as follows:

From the RS-232 9-pin D-sub serial port connect:

- Pin 2 to the TX pin on the **KIT-401** RS-232 terminal block
- Pin 3 to the RX pin on the **KIT-401** RS-232 terminal block
- Pin 5 to the G pin on the **KIT-401** RS-232 terminal block

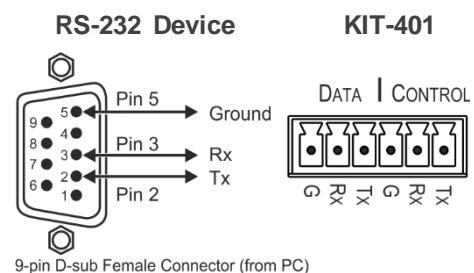

Connecting an Occupancy Sensor to the TOGL Pin

The KIT-400R TOGL pin ⁽²⁹⁾ function is defined via the KIT-400R OSD menu (see [Defining the TOGGLE PIN on KIT-400R](#) on page 23). By default, the display toggles on or off when momentarily connected. By setting the Toggle function, you can set the pin for level-triggering rather than edge-triggering (i.e., constant contact connection rather than momentary connection), allowing, for example, connection to an occupancy sensor that triggers the toggle commands.

 Instead of a push-to-make switch, TOGGLE may be configured to operate with a standard SPST switch or for TTL level detection (for example, to use with an occupancy sensor).

You can use an occupancy sensor to turn on the display and auto sync off to turn it off once it is not used, as described in the following example:

- An occupancy sensor is connected to the TOGL pin.
- The TOGL pin is set to ON (see [Defining the TOGGLE PIN on KIT-400R](#) on page 23) so that the display is turned on when the occupancy sensor detects the presence of people in the room. (Set the sensor to short the TOGL pin to ground upon detecting occupancy).
- Auto SYNC OFF is set to Enable (see [Setting Sleep Mode](#) on page 21) so that when the room is no longer in use, the display turns off 2 minutes after an input signal is no longer detected.

You can also set the TOGL pin to OFF so that when the sensor detects no people in the room the display turns off. (Set the sensor to short the TOGL pin to ground when occupancy is not detected).

Wiring RJ-45 Connectors

This section defines the HDBT pinout, using a straight pin-to-pin cable with RJ-45 connectors.

 For HDBT cables, it is recommended that the cable ground shielding be connected/soldered to the connector shield.

EIA / TIA 568B	
PIN	Wire Color
1	Orange / White
2	Orange
3	Green / White
4	Blue
5	Blue / White
6	Green
7	Brown / White
8	Brown

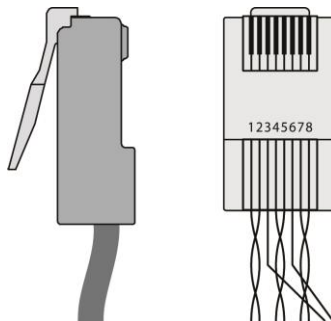

Operating and Controlling KIT-401

Using Front Panel Buttons

Press the **KIT-400R** front panel buttons to:

- Locally select (23) the HDMI or HDBT inputs (when the SELECT button is not locked).
- Control device operation, using the MENU (26), ENTER (27) (when in the OSD menu), + (29) and – (28), buttons (see [Using the OSD Menu on KIT-400R](#) on page 17).
- Freeze the image on the output, using FREEZE button.
- Reset to XGA, using ENTER and FREEZE+ buttons.
- Reset to 1080p, using MENU and – buttons.

Using Remote Control Switches

The following table describes the function of the remote contact closure switches on **KIT-401T** (10) and **KIT-400R** (29).

Pin Name	Function
KIT-401T	
SELECT	Short press – Select the input. Long press – Adjust the VGA phase shift.
REMOTE HDMI	Select the HDMI IN input on KIT-400R .
VOL UP	Increase the analog audio output level. Short press – Increase volume by one step. Long Press – Increase the volume from 0 to 100% in 10 seconds.
VOL DN	Decrease the analog audio output level. Short press – Decrease volume by one step. Long Press – Decrease the volume from 100% to 0 in 10 seconds.
KIT-400R	
TOGL	For connection to an occupancy sensor, or to a single ON/OFF switch. Configurable via the OSD for connection to a button which toggles between display on and display off (instead of using two separate buttons for on and off), or turning the display on and off according to whether a switch is open or closed (for example, when using an occupancy sensor). See Defining the TOGGLE PIN on KIT-400R on page 23.
OFF	Turn off the display.
ON	Turn on the display.

KIT-401T

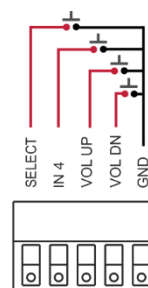

KIT-400R

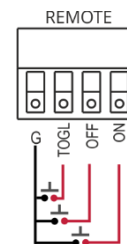

Setting KIT-401T DIP-switches

A switch that is down is on; a switch that is up is off. By default, all the switches are set to off (up).

-  DIP-switches 1 and 2 are both set to OFF (up).

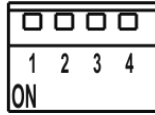



Figure 6: KIT-401T SETUP DIP-Switches

-  After changing a DIP-switch you must power cycle the device to implement the change.

Audio Switching Selection

Use DIP-switches 3 and 4 to define the audio input source.

DIP-switch 3	DIP-switch 4	Audio Input Selection
Off (up)	Off (up)	Automatic – Priority selection: Embedded HDMI → analog Audio In (high to low priority).
Off (up)	On (down)	Automatic – Priority selection: Analog Audio In → embedded HDMI (high to low priority).
On (down)	Off (up)	Embedded HDMI.
On (down)	On (down)	Analog Audio In.

Tunneling RS-232 data between KIT-401T and KIT-400R

KIT-401 tunnels RS-232 data between the transmitter and receiver in any of the following ways:

- [Controlling Via a Control System](#) on page [14](#).
- [Controlling a Sink Device Via the DATA Ports](#) on page [16](#).
- [Controlling Via Maestro on the Transmitter](#) on page [16](#).

Controlling Via a Control System

You can control the receiver and/or a connected sink device via a control system that is connected to the CONTROL port on the KIT-401T.

-  When sending a command to the receiver from the Maestro internal port or from any of the transmitter communication ports (RS-232 or TCP/UDP), note that – in addition to abiding by the standard P3K conventions – the data within the quotation marks (“ ” or ‘ ’) may not include the symbols #, and <CR>(/x0d).

Controlling a Sink Device Via the DATA Ports

Raw data can pass between the DATA ports on the transmitter and receiver (13 for KIT-401T and 38 KIT-400R) directly to/from a controlled device and control system.

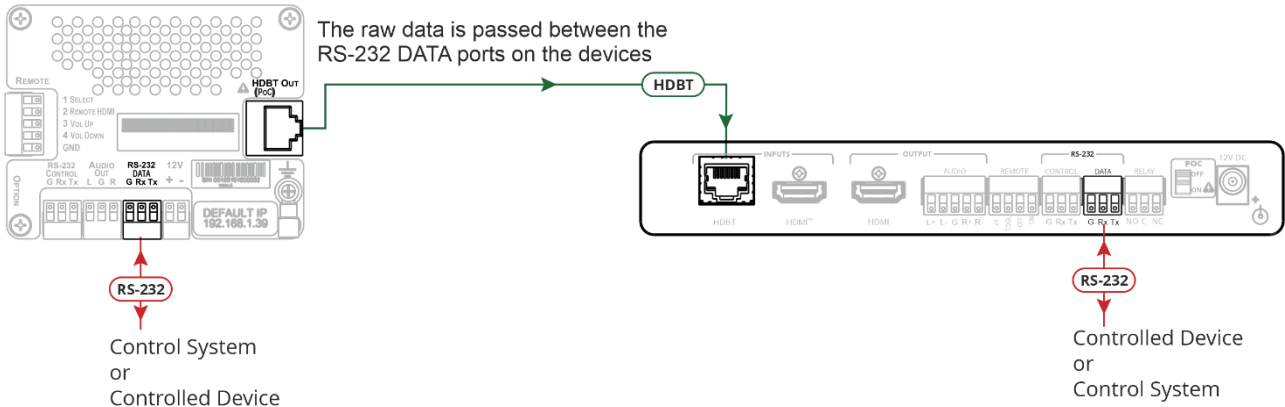

Figure 9: Controlling a Sink Device on the Receiver via the Data Ports

Controlling Via Maestro on the Transmitter

You can control the receiver and/or a connected sink device via the KIT-401T Kramer Maestro.

Controlling the Receiver

To control the receiver via Maestro at the transmitter, send a command via the RS232_HDBT port in Maestro. For example, to open the relay contacts (RELAY-STATE 1,0), send the RELAY-STATE 1,0 command from Maestro, via HDBT to the KIT-400R.

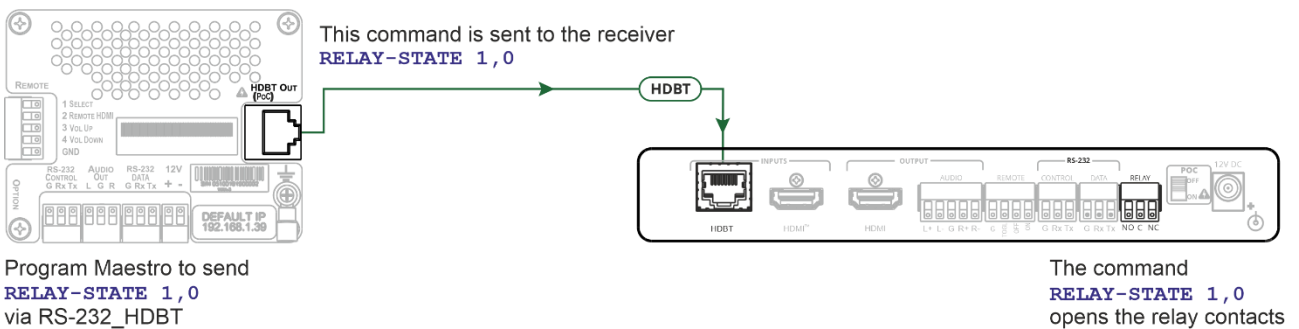

Figure 10: Controlling the Receiver via Maestro

Controlling a Sink Device Connected to the Receiver

You can control a sink device via **KIT-401T** Maestro. To control the sink device via Maestro at the transmitter, send a command via the RS232_HDBT port in Maestro.

For example, to turn the display off (DISPLAY OFF), send the #TUNNEL-CTRL 1,1,"TUNNEL-232 'DISPLAY OFF'9600"<CR> command from Maestro, via HDBT to the **KIT-400R**.

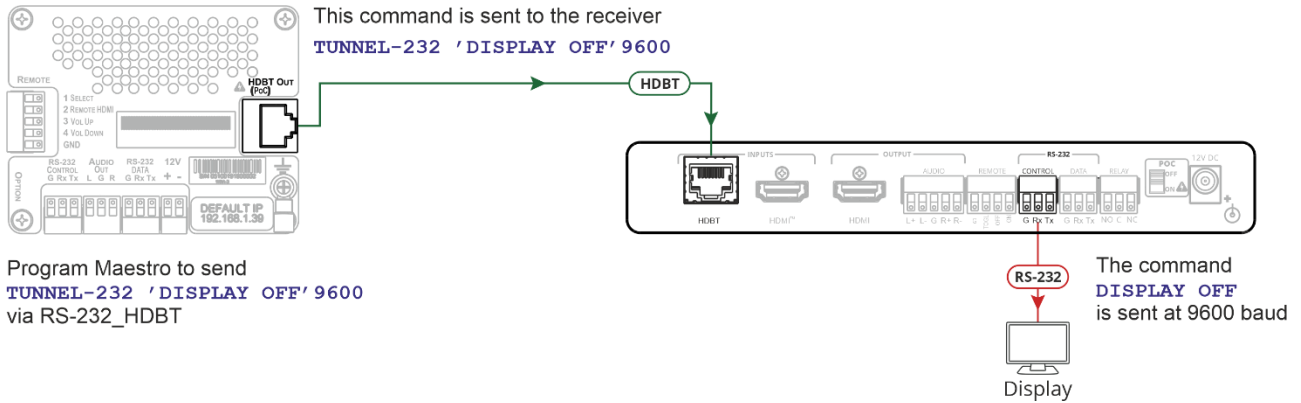

Figure 11: Controlling a Sink Device on the Receiver via Maestro

Using the OSD Menu on KIT-400R

KIT-400R enables controlling and defining the device parameters via the OSD, using the front panel MENU buttons.

To enter and use the OSD menu buttons:

1. Press MENU.
2. Press:
 - **ENTER** to accept changes and to change the menu settings.
 - **Arrow buttons** to move through the OSD menu, which is displayed on the video output.
 - **EXIT** to exit the menu.



The default OSD timeout is set to 10 seconds.

Use the OSD menu to perform the following operations:

- [Adjusting Image Parameters](#) on page [18](#).
- [Selecting an Input Signal](#) on page [19](#).
- [Setting Output Parameters](#) on page [19](#).
- [Setting Audio Parameters](#) on page [20](#).
- [Setting OSD Parameters](#) on page [20](#).
- [Setting HDCP](#) on page [21](#).
- [Setting Sleep Mode](#) on page [21](#).
- [Setting Switching Mode](#) on page [22](#).
- [Setting FREEZE Button Functionality](#) on page [22](#).
- [Managing EDID via OSD](#) on page [22](#).
- [Defining the TOGGLE PIN on KIT-400R](#) on page [23](#).
- [Manually Switching the Relay](#) on page [24](#).
- [Defining CEC Functionality](#) on page [24](#).
- [Defining Power-up State](#) on page [25](#).
- [Viewing Device Information](#) on page [25](#).
- [Performing a Reset](#) on page [25](#).

Adjusting Image Parameters

KIT-400R enables adjusting the image parameters such as contrast, brightness and so on.

To adjust the image parameters:

1. On the front panel press **MENU**. The menu appears.
2. Click **Picture** and define the image parameters according to the information in the following table:

Menu Item	Function	
Contrast	Set the contrast.	
Brightness	Set the brightness.	
Finetune	Video	HUE – set the color hue.
		SATURATION – set the color saturation.
		SHARPNESS – set the sharpness of the picture.
		NR (Noise Reduction) – select the noise reduction filter: Off (default), Low, Middle or High.
Color	Set the Red, Green and Blue shades.	

Image parameters are adjusted.

Selecting an Input Signal

Select the **KIT-400R** input source via the OSD menu.

To set the input source:

1. On the front panel press **MENU**. The menu appears.
2. Click **INPUT** and select the **SOURCE**
3. Press **ENTER** and select HDMI or HDBT.

An input signal is selected.

Locking KIT-400R Input Buttons

KIT-400R enables locking the input select buttons.

To set the input source:

1. On the front panel press **MENU**. The menu appears.
2. Click **INPUT** and select **INPUT BUTTON LOCK**.
3. Press **ENTER** and select ON or OFF.

Input select buttons are locked.

Setting Output Parameters

KIT-400R enables setting output parameters such as the size of the image and output resolution via the OSD MENU buttons.

To set the output parameters:

1. On the front panel press **MENU**. The menu appears.
2. Click **OUTPUT** and define the output parameters according to the information in the following table:

Menu Item	Function			
Size	Set the size of the image: Over Scan, Full, Best Fit (default), Pan Scan, Letter Box, Under 2, Under 1, Follow In.			
Resolution	Select the output resolution (default, Native HDMI):			
	640x480 @60Hz	1600x1200 @60Hz	3440x1440 @30Hz	1920x1080P @50Hz
	800x600 @60Hz	1680x1050 @60Hz	3440x1440 @60Hz	1920x1080P @60Hz
	1024x768 @60Hz	1920x1200 @60Hz RB	720x480P @60Hz	2560x1080P @50Hz
	1280x768 @60Hz	2560x1600 @60Hz RB	720x576P @50Hz	2560x1080P @60Hz
	1280x800 @60Hz	1920x1080 @60Hz	1280x720P @50Hz	3840x2160P @24Hz
	1280x1024 @60Hz	1280x720 @60Hz	1280x720P @60Hz	3840x2160P @25Hz
	1360x768 @60Hz	2048x1080 @50Hz	1920x1080P @24Hz	3840x2160P @30Hz
	1400x1050 @60Hz	2048x1080 @60Hz	1920x1080P @25Hz	3840x2160P @50Hz
	1440x900 @60Hz	2560x1440 @60Hz RB	1920x1080P @30Hz	3840x2160P @60Hz

Output parameters are defined.

Setting Audio Parameters

KIT-400R enables defining the audio delay time and the output volume.

To set the audio:

1. On the front panel press **MENU**. The menu appears.
2. Click **Audio** and define the audio parameters according to the information in the following table:

Menu Item	Function
DELAY	Set the audio delay time (lip sync) to off, 40ms (default), 110ms or 150ms.
AUDIO VOLUME	Set the AUDIO OUT output volume (default is 80 = 0dB).

Audio parameters are defined.

Setting OSD Parameters

KIT-400R enables adjusting OSD parameters for your convenience via the OSD MENU buttons.

To set the OSD parameters:

1. On the front panel press **MENU**. The menu appears.
2. Click **OSD** and define the OSD parameters according to the information in the following table:

Menu Item	Function
H-POSITION	Set the horizontal position of the OSD.
V-POSITION	Set the vertical position of the OSD.
TIMER	Set the timeout period to Off or up to 60 seconds (default 10).
TRANSPARENCY	Set the OSD background between 100 (transparent) and 0 (opaque).
DISPLAY	Select the information displayed on-screen during operation: Info (default) –Information appears for 10 seconds. On –Information appears constantly. Off – Information does not appear.

OSD parameters are set.

Setting HDCP

KIT-400R enables setting the HDCP on the input and on the output via the front panel MENU buttons.

To set the HDCP on the inputs and output:

1. On the front panel press **MENU**. The menu appears.
2. Click **Advanced** and define the HDCP parameters according to the information in the following table:

Menu Item	Function
HDCP ON HDBT INPUT	Set HDCP support ON (default) or OFF. Note that: <ol style="list-style-type: none"> 1. HDCP must be enabled (ON) to support HDCP encrypted sources. 2. Sources such as Mac computers always encrypt their outputs when detecting that the sink supports HDCP. If the content does not require HDCP, you can prevent these sources from encrypting by disabling (OFF) HDCP on the input.
HDCP ON HDMI INPUT	
HDCP (OUT)	Select FOLLOW OUTPUT (default) or FOLLOW INPUT on HDMI OUT. Select FOLLOW OUTPUT (recommended) for the scaler to match its HDCP output to the HDCP setting of the acceptor to which it is connected. Select FOLLOW INPUT to change its HDCP output setting according to the HDCP of the input (recommended when the output is connected to a splitter/switcher).

HDCP is set on the input/output.

Setting Sleep Mode

Auto Sync Off turns off the output after a period of not detecting a valid video signal on the input(s) until a valid input is again detected or any keypad button is pressed.

KIT-400R enables configuring the Auto Sync Off delay time when a connected display enters sleep mode.

To set Auto Sync Off:

1. On the front panel press **MENU**. The menu appears.
2. Click **Advanced** and select **Auto Sync Off**.
3. Define Auto Sync Off according to the information in the following table:

Menu Item	Function
Disable	Leave outputs active always.
Enable	Disable outputs after ~ 2 minutes of no input detection.

Sleep mode is defined.

Setting Switching Mode

KIT-401 enables configuring for automatic switching of the input source upon signal loss or when a source is plugged in.

To set the switching mode:

1. On the front panel press **MENU**. The menu appears.
2. Click **ADVANCED** and select **AUTO SCAN**.
3. Click **ENTER** and select **ENABLE** to allow auto scanning or **DISABLE** (default) for manual switching.

Switching mode is defined.

Setting FREEZE Button Functionality

KIT-401 enables defining the function of the **FREEZE** front panel button (29). For example, the **FREEZE** button can be defined to freeze the image and mute the audio or only freeze the image.

To set the functionality of the **FREEZE** front panel button:

1. On the front panel press **MENU**. The menu appears.
2. Click **ADVANCED** and select **FREEZE**.
3. Set panel lock mode according to the information in the following table:

Menu Item	Function
FREEZE + MUTE	Press FREEZE to mute the audio output and freeze the image.
ONLY FREEZE	Press FREEZE to freeze the image.
ONLY MUTE	Press FREEZE to mute the output audio.

FREEZE button mode is defined.

Managing EDID via OSD

KIT-400R enables managing the EDID via the OSD menu buttons.

To manage the EDID:

1. On the front panel press **MENU**. The menu appears.
2. Click **ADVANCED**, select **EDID Manage**
3. Press **ENTER** and define the EDID parameters according to the information in the following table:

Menu Item	Function
HDBT EDID	For the HDBT input, select a built-in EDID file and press enter: Def. 1080P, Def. 4K2K(3G), Def. 4K2K(3G 4:2:0) (default), USER 1, USER 2 or Output.
HDMI EDID	For the HDMI input, select a built-in EDID file and press enter: Def. 1080P, Def. 4K2K(3G), Def. 4K2K(6G) (default), USER 1, USER 2 or Output.

The selected built-in EDID file is saved on the selected input.

Uploading EDID from an External File

To select the EDID from an external file:

1. Upload the EDID file to a memory stick.
The EDID file name should be USER_EDID1.bin or USER_EDID2.
2. On the front panel press **MENU**. The OSD menu appears.
3. Click **ADVANCED** and select **EDID UPLOAD**.
4. Select **USER EDID**.



The external EDID file is saved to the device.

Defining the TOGGLE PIN on KIT-400R

KIT-400R enables defining the TOGGLE pin (36) functionality. For example, you can define this pin to select one of the 2 inputs, turn the display on or off and so on.

To define the TOGGLE PIN functionality:

1. On the front panel press **MENU**. The menu appears.
2. Click **Toggle Pin** and define the TOGGLE pin functionality according to the information in the following table:

Menu Item	Function
EDGE	Set for edge triggering (momentary connection): Toggles between switching the display on and off (using CEC commands) each time the TOGL pin is momentarily connected to ground.
ON	Sends a CEC signal to turn the display ON when the TOGL pin is shorted to ground.  Select ON when using together with an occupancy sensor that is set up to short the sensor wire to ground when detecting the presence of people in the room (see Connecting an Occupancy Sensor to the TOGL Pin on page 12).
OFF	Sends a CEC signal to turn the display OFF when the TOGL pin is shorted to the ground.  Select OFF when using together with an occupancy sensor that is set up to short the sensor wire to ground when detecting no people in the room (see Connecting an Occupancy Sensor to the TOGL Pin on page 12).
INPUT SELECT	Set to select between inputs (HDBT or HDMI).

TOGGLE pin functionality is defined.

Manually Switching the Relay

You can manually set the state of the relay (39) in **KIT-400R** via the OSD.

To define the relay functionality:

1. On the front panel press **MENU**. The menu appears.
2. Click **Advanced**.
3. Click **Relay** and define its state according to the information in the following table:

Menu Item	Function
ON	Turn the relay ON. When on, the relay's coil is energized, meaning C and NO are shorted, and there is an open circuit between C and NC.
OFF	Turn the relay OFF When off, the relay's coil is not energized, meaning C and NC are shorted, and there is an open circuit between C and NO.

Relay is manually switched.

Defining CEC Functionality

KIT-400R can be set to initiate and send CEC commands to the connected display, or to pass CEC commands from its HDMI input to the connected display.

To set the CEC (Consumer Electronic Control) functionality:

1. On the front panel press **MENU**. The menu appears.
2. Click **Advanced** and select **Output CEC Bypass**.
3. Press **ENTER** and select:
 - **OFF** – **KIT-400R** automatically sends CEC commands to shut down the output display after a timeout period when no input signal is found and to power up the display when the input returns.
 - **ON** – CEC commands pass from the HDMI input to the display. (**KIT-400R** does not automatically send CEC on and off commands).



KIT-400R either passes CEC commands between its HDMI input and the display, or it initiates and sends on and off commands to the display.

CEC is enabled/disabled.

Defining Power-up State

KIT-400R enables defining which input is selected when the device is powered up.

To define the power up state:

1. On the front panel press **MENU**. The menu appears.
2. Select **ADVANCED**.
3. Click **POWER UP STATE**.
4. Press **ENTER** and define the selected input:

Menu Item	Function
Select HDMI	KIT-400R's HDMI input is selected when the unit is powered up.
Select HDBT	KIT-400R's HDBT input is selected when the unit is powered up.
Last Selected	When powered up, KIT-400R switches to the input which was selected before being powered down.

Power-up state mode is defined.

Viewing Device Information

Device information includes the selected source, the input and output resolutions, and the software version.

To view the information:

1. On the front panel press **MENU**. The menu appears.
2. Click **INFORMATION** and view the input source selection and its resolution, the output resolution and the software version.

Performing a Reset

KIT-400R enables performing factory reset via the front panel MENU buttons.

To reset the device:

1. On the front panel press **MENU**. The menu appears.
2. Click **Factory** and select **RESET ALL**.
Wait for completion of factory reset (resolution is set to Native).

Device is reset.

Operating via Ethernet

You can connect to **KIT-401T** via Ethernet using either of the following methods:

- Directly to the PC using a crossover cable (see [Connecting Ethernet Port Directly to a PC](#) on page 26).
- Via a network hub, switch, or router, using a straight-through cable (see [Connecting Ethernet Port via a Network Hub](#) on page 28).

Note: If you want to connect via a router and your IT system is based on IPv6, speak to your IT department for specific installation instructions.

Connecting Ethernet Port Directly to a PC

You can connect the Ethernet port of **KIT-401** directly to the Ethernet port on your PC using a crossover cable with RJ-45 connectors.



This type of connection is recommended for identifying **KIT-401** with the factory configured default IP address.

After connecting **KIT-401** to the Ethernet port, configure your PC as follows:

1. Click **Start > Control Panel > Network and Sharing Center**.
2. Click **Change Adapter Settings**.
3. Highlight the network adapter you want to use to connect to the device and click **Change settings of this connection**.

The Local Area Connection Properties window for the selected network adapter appears as shown in [Figure 12](#).

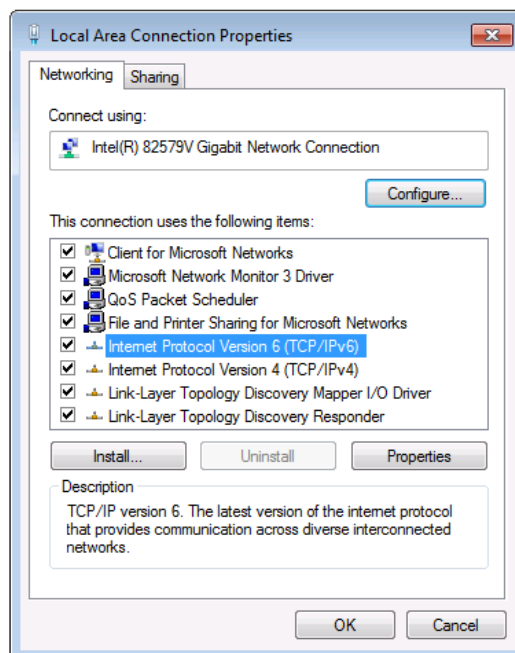

Figure 12: Local Area Connection Properties Window

4. Highlight either **Internet Protocol Version 6 (TCP/IPv6)** or **Internet Protocol Version 4 (TCP/IPv4)** depending on the requirements of your IT system.

5. Click **Properties**.

The Internet Protocol Properties window relevant to your IT system appears as shown in [Figure 13](#) or [Figure 14](#).

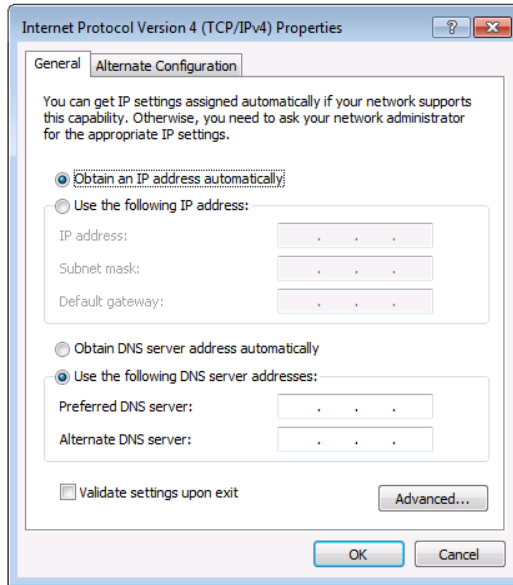

Figure 13: Internet Protocol Version 4 Properties Window

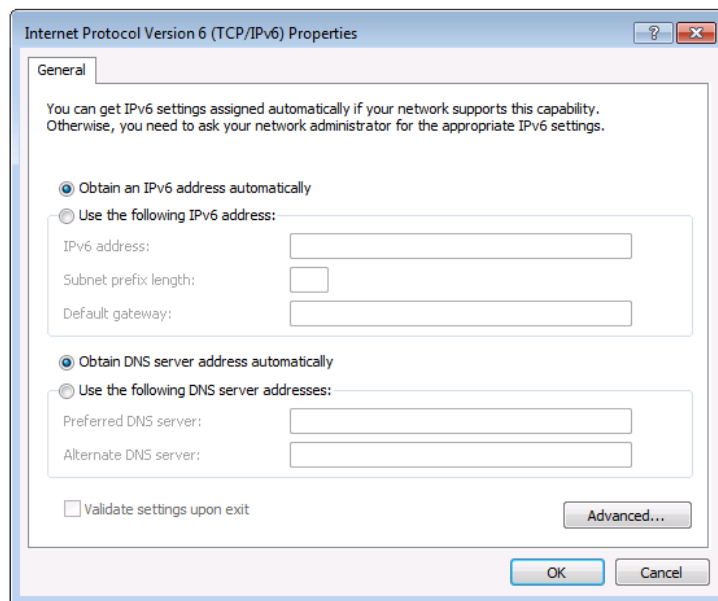

Figure 14: Internet Protocol Version 6 Properties Window

6. Select **Use the following IP Address** for static IP addressing and fill in the details as shown in [Figure 15](#).

For TCP/IPv4 you can use any IP address in the range 192.168.1.1 to 192.168.1.255 (excluding 192.168.1.39) that is provided by your IT department.

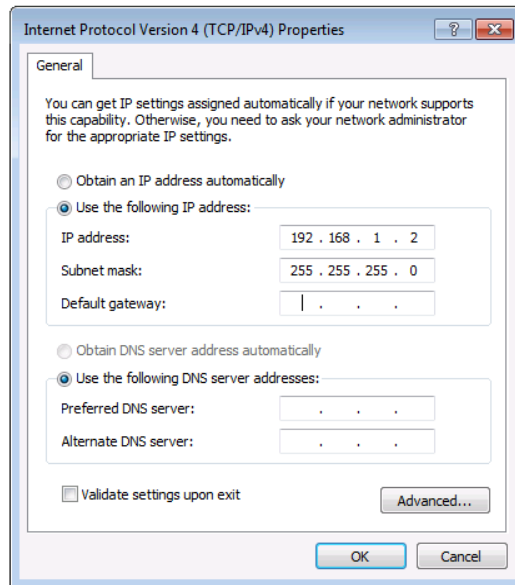

Figure 15: Internet Protocol Properties Window

7. Click **OK**.
8. Click **Close**.

Connecting Ethernet Port via a Network Hub or Switch

You can connect the Ethernet port of **KIT-401** to the Ethernet port on a network hub or using a straight-through cable with RJ-45 connectors.

Configuring Ethernet Port

You can set the Ethernet parameters via the embedded webpages.

Using Embedded Webpages

The webpages enable you to control **KIT-401** via the Ethernet. The webpages include all the OSD items and are accessed using a Web browser and an Ethernet connection.

Browsing Webpages

Before attempting to connect:

- Perform the procedures described in [Operating via Ethernet](#) on page [26](#).
- Ensure that your browser is supported.

The following operating systems and Web browsers are supported:

Operating Systems	Browser
Windows 7	IE
	Firefox
	Chrome
	Safari
Windows 10	IE
	Edge
	Firefox
	Chrome
Mac	Safari
iOS	Safari
Android	N/A

To browse the KIT-401 webpages:

1. Open your Internet browser.
2. Type the IP address of the device in the address bar of your browser. For example, the default IP address:



The Authentication window appears (if set, security is enabled):

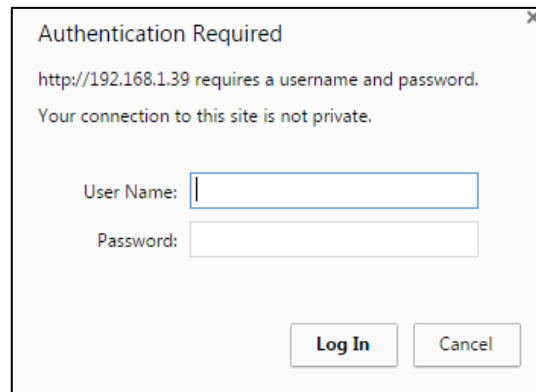

Figure 16: Using the Embedded Webpages – Authentication

3. Enter the **User Name** and **Password** (Admin/Admin) and click **OK**.
The Switching page appears:

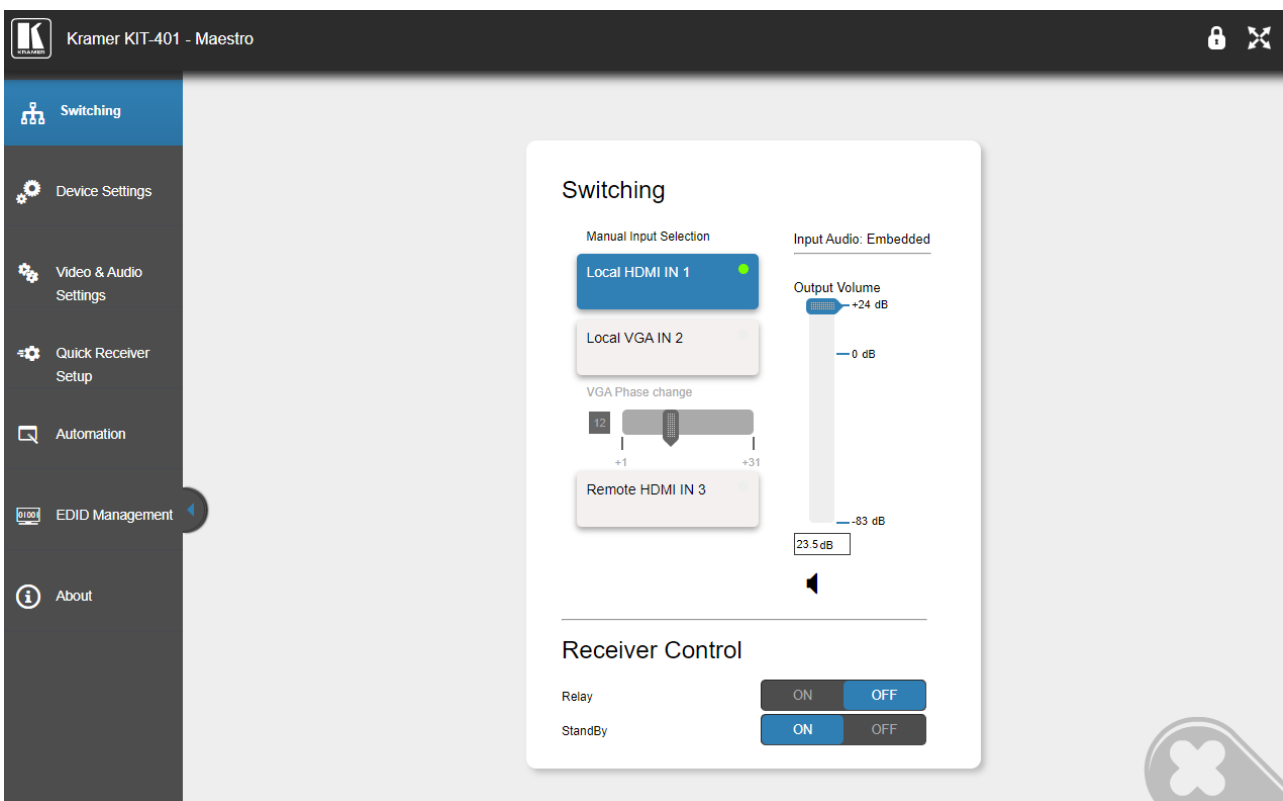

Figure 17: Switching Page with Navigation List on Left

4. Click the desired webpage or click the arrow to hide the navigation list.

KIT-401T webpages enable performing the following actions:

- [Switching and adjusting Port Signals](#) on page [31](#).
- [Defining General settings](#) on page [32](#).
- [Configuring Network Settings](#) on page [34](#).
- [Defining Time and Date](#) on page [36](#).
- [Upgrading the Firmware](#) on page [37](#).
- [Setting Authentication](#) on page [39](#).
- [Defining Video and Audio Settings](#) on page [41](#).
- [Defining Receiver Settings](#) on page [43](#).
- [Configuring Device Automation](#) on page [44](#).
- [Managing EDID](#) on page [60](#).
- [Viewing About Page](#) on page [66](#).

Switching and adjusting Port Signals

The Switching webpage enables performing the following functions:

- [Selecting an Input Manually](#) on page [31](#).
- [Viewing the Audio Input Source](#) on page [32](#).
- [Adjusting the Audio Output Volume](#) on page [32](#).
- [Controlling Receiver Parameters](#) on page [32](#).

Selecting an Input Manually

Select one of 4 inputs to switch to the output.



A green dot, on an input button, indicates that it is connected to an active source, as shown in the example in [Figure 17](#), for HDMI IN 1.

To select an input manually:

1. In the Navigation pane, click **Switching**. The Switching page appears (see [Figure 17](#)).
2. Click any of the following buttons:
 - Local HDMI IN 1.
 - Local VGA IN 2.



When selecting the VGA input, adjust the phase of the VGA input sampling by entering the value or using the slider.

- Remote HDMI IN 3.
The remote HDMI IN input is located on the **KIT-400R**.

An input is selected.

Viewing the Audio Input Source

The audio input source is defined via DIP-switches 3 and 4 on the **KIT-401T** (see [Setting KIT-401T DIP-switches](#) on page 14). You can view the input audio source in the Switching page.

1. In the Navigation pane, click **Switching**. The Switching page appears ([Figure 17](#)).
2. View the input audio source according to DIP-switch setup.

The input audio source is viewed.

Adjusting the Audio Output Volume

KIT-401T enables adjusting the audio output volume via the embedded webpages.

To adjust the audio output volume:

1. In the Navigation pane, click **Switching**. The Switching page appears ([Figure 17](#)).
2. Do any of the following:
 - Enter the audio volume value.
 - Use the slider to set the volume.
 - Click  to mute the audio

Audio output volume is adjusted.

Controlling Receiver Parameters

Using the **KIT-401T** Switching webpage, you can control **KIT-400R**'s relay, and you can put **KIT-400R** into standby mode or wake it from standby mode.

To control KIT-400R parameters:

1. In the Navigation pane, click **Switching**. The Switching page appears ([Figure 17](#)).
2. Do the following:
 - Click **ON** or **OFF** to energize or release the relay.
 - Click **ON/OFF** to put the device in standby mode or wake it from standby mode.

KIT-400R parameters are set.

Defining General settings

KIT-401T enables performing the following actions:

- Changing the device name (click **Set** to save the name).
- [Defining Remote Buttons Functionality](#) on page 33.
- [Saving and Loading Settings](#) on page 34.
- [Performing a Factory Reset](#) on page 34.

Defining Remote Buttons Functionality

KIT-401T includes remote contact closure switches (14). You can define the functionality of these buttons via the embedded webpages.

To define the contact closure switches behavior:

1. In the Navigation pane, click **Device Settings**. The Switching page appears, showing the General settings tab.

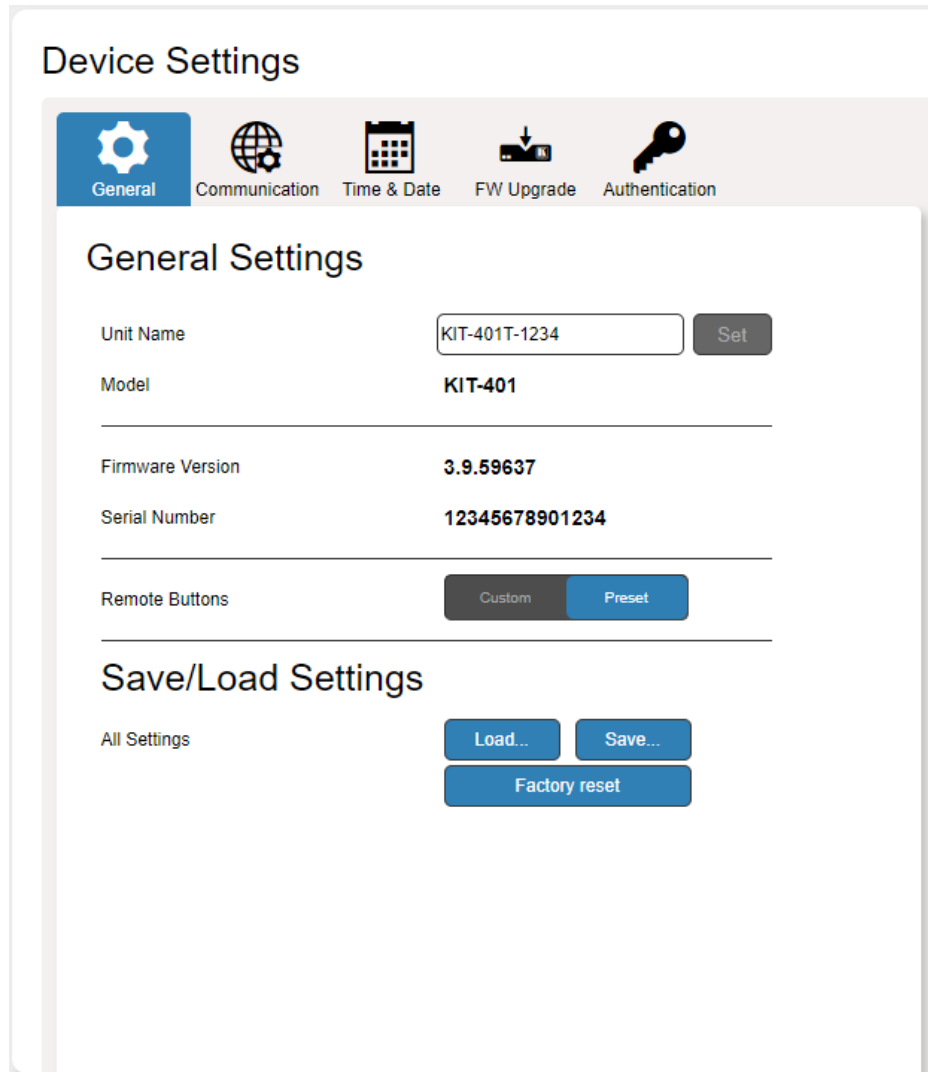

Figure 18: Device Settings Page – General Settings Tab

2. Select Remote Button behavior:
 - **Preset** (default) – The remote contact-closure switches connected to the 5-pin terminal block connector on **KIT-401T** operate according to their preset functions (SELECT, REMOTE HDMI, VOL UP and VOL DN), as printed on the panel of the device. See [Using Remote Control Switches](#) on page 13.
 - **Custom** – The remote contact-closure switches connected to the 5-pin terminal block connector on **KIT-401T** are defined by the user for use as Maestro Triggers to send Maestro Script (e.g., closing the lights and opening a projector screen upon HDMI trigger). See [Configuring Device Automation](#) on page 44.

Remote contact closure switches behavior is defined.

Saving and Loading Settings

KIT-401T enables you to save a configuration to recall it in the future.

Saving a Configuration

To save the current configuration:

1. Configure the device as required.
2. In the Navigation pane, click **Device Settings**. The Switching page opens ([Figure 18](#)).
3. Click **Save**. The Save File window appears.



When using Chrome, the file is automatically saved in the Downloads folder.

The current configuration is saved.

Loading a Configuration

To load a configuration:

1. In the navigation pane click **Device Settings**. The Switching page opens ([Figure 18](#)).
2. Click **Upload**. An Explorer window opens.
3. Select the required file and click **Open**.

The device is configured according to the saved preset.

Performing a Factory Reset

To reset the device to its factory default values:

1. In the Navigation pane, click **Device Settings**.
The Device Settings page appears ([Figure 18](#)).
2. Click **Factory reset**.

The following message appears. A communication warning message appears.

3. Click **OK** to start factory reset and follow the instructions on-screen.

The device resets to its default parameters.

Configuring Network Settings

KIT-401 enables you to configure network settings for your device.



For proper settings and before changing to DHCP, consult your Network administrator.

To configure network settings:

1. Click **Device Settings** from the Navigation Pane. The Device Settings page appears.
2. Click the **Communication** tab. The Communication tab appears.

Device Settings

General **Communication** Time & Date FW Upgrade Authentication

IP Settings

DHCP ON OFF

IP address

Mask address

Gateway address

Mac address **00-1d-56-03-8d-17**

UDP port

TCP port

Figure 19: Device Settings Page – Communication Tab

3. Change the network settings as required.

–OR–

If you want the device to obtain an IP address via DHCP server, click DHCP **ON**.

If DHCP is ON and you want to turn it off:

- a. Click DHCP **OFF**. The DHCP OFF message appears.

DHCP OFF

Set a new IP address.
Following this you will lose your connection to the device.
To reconnect, enter the new IP address in your Web browser.

Custom IP

Default IP **192.168.1.39**

Figure 20: Setting DHCP Off

- b. Check a Custom IP (and enter the address) or use the default IP.
 - c. Click **Apply**.
4. Verify that the TCP/UDP port is correct.
 5. Click **Set**.

The webpage logs out and the browser reloads with the new network information.

Defining Time and Date

KIT-401T enables setting a device Time and Date locally or by Syncing the Device Time and Date to any server around the world.

Setting Time and Date Locally

To set the device time and date locally:

1. In the Navigation pane, click **Device Settings**. The Device Settings page appears.
2. Select the Time & Date tab. The Time & Date tab appears.

The screenshot shows the 'Device Settings' page with the 'Time & Date' tab selected. The navigation bar includes icons for General, Communication, Time & Date, FW Upgrade, and Authentication. The 'Time And Date' section contains the following settings:

- Device Date: 9/10/2021
- Device Time: 10:54
- Time Zone: (GMT+00:00) Greenwich
- Daylight Savings Time: NO
- Use Time Server (NTP): NO
- Time Server Address: 129.6.15.30
- Server Status: Unreachable
- Sync Every Day at (0-23): 0 Hrs

A 'Save Changes' button is located at the bottom of the settings area.

Figure 21: Device Settings Page – Time and Date Tab

3. Set Use Time Server (NTP) to **NO**.

Device Time & Date Fields are enabled, and network fields are disabled.

4. If required, change the:
 - Device date.
 - Device time.
 - Time zone.
5. Select the time zone.
6. Set daylight savings time status (YES or NO).
7. Click **Save Changes**.

The device date and time is set.

Syncing Time and Date Via a Server

To sync device time and date to a server:

1. In the Navigation pane, click **Device Settings**. The Device Settings page appears.
2. Select the Time & Date tab. The Time & Date tab appears ([Figure 21](#)).
3. Set Use Time Server (NTP) to **YES**.
Device Time & Date Fields are disabled, and network fields are enabled.
4. Enter the time server address.
5. Define the daily sync time from the drop-down box.
6. Click **Save Changes**.

The devices date and time are synchronized to the server address entered.

Upgrading the Firmware

KIT-401T enables updating the firmware via the embedded webpages.

To upgrade the firmware:

1. In the Navigation pane, click **Device Settings**. The Device Settings page appears.
2. Select the FW Upgrade tab. The FW Upgrade tab appears.

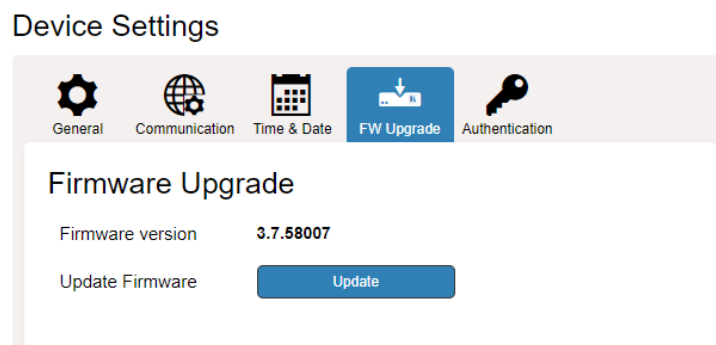

Figure 22: Device Settings Page – FW Upgrade Tab

3. Click **Update**.

The Windows browser opens.

4. Browse to the required file and click **Open**. The following warning appears.



Figure 23: Device Settings Page – FW Upgrade Warning

5. Click **OK**. The firmware files are uploaded, and a progress bar is displayed.





Do not interrupt the process or the **KIT-401** may be damaged.

6. When the process is complete reboot the device.

KIT-401T firmware is upgraded.

Setting Authentication

KIT-401T enables activating device security and defining logon authentication details. The upper right corner of the webpage displays  or  indicating whether authentication is required.



By default, the webpages are secured (username and password are both: **Admin**).

Disabling Authentication

To undo authentication:

1. In the Navigation pane, click **Device Settings**. The Device Settings page appears.
2. Select the Authentication. The Authentication tab appears.

Device Settings

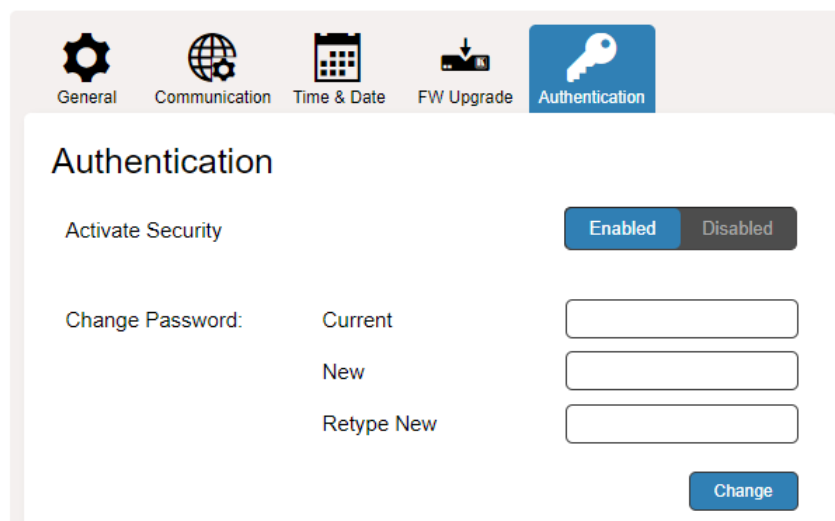

Figure 24: Device Settings Page – Authentication Tab

3. Click the **Disabled** button for Active Security. A confirmation message appears.

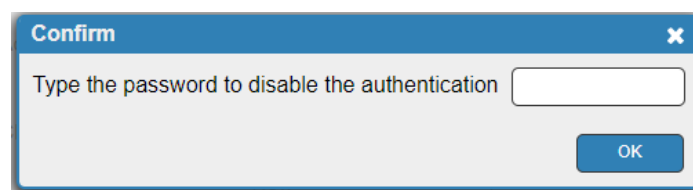



Figure 25: Authentication Tab – Confirmation Message.

4. Enter current password.
5. Click **OK**.

The webpage refreshes, the password fields disappear, and the upper right icon changes to .

Enabling Authentication

To set authentication:

1. In the Navigation pane, click **Device Settings**. The Device Settings page appears.
2. Select the Authentication. The Authentication tab appears ([Figure 24](#)).
3. Click the **Enabled** button for Active Security. The following warning appears.

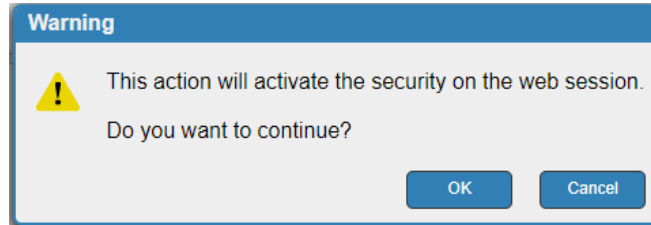



Figure 26: Authentication Tab – Activating Security Message

4. Click **OK**.
5. Type the current password and new password twice.
6. Click the **Change** button. The upper right icon changes to  and the following warning appears.

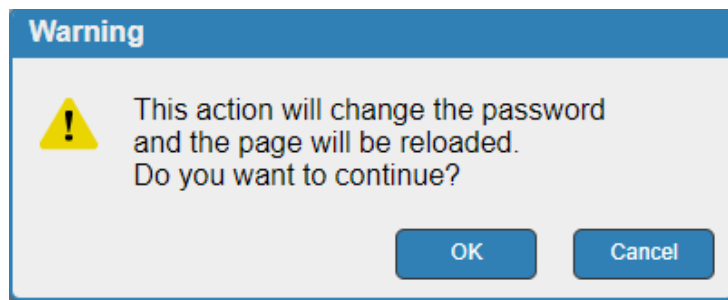

Figure 27: Authentication Page – Changing the Password Message

The webpage refreshes and the password fields are visible, and a confirmation message appears.

7. Click **OK**.

The password has changed, and the page is reloaded.

Defining Video and Audio Settings

KIT-401T enables performing the following actions:

- [Viewing Audio Settings](#) on page [41](#).
- [Enabling Audio Only](#) on page [42](#).
- [Setting HDCP Support](#) on page [42](#).
- [Setting Audio and Video Timeouts](#) on page [42](#).

Viewing Audio Settings

View the audio selection mode.

To view the audio selection mode:

1. In the Navigation pane, click **Video & Audio Settings**. The Device Settings page appears.

Video & Audio Settings

Audio

Audio selection mode: Auto: Priority switching

Current selection: Embedded

Audio only mode:

HDCP Support

Local HDMI IN 1:

Timeout

	Video	Audio
When the HDMI signal is lost, leave 5V power ON and delay switching for	<input type="text" value="10 sec"/>	<input type="text" value="5 sec"/>
When the HDMI cable is unplugged, delay switching for	<input type="text" value="0 sec"/>	<input type="text" value="0 sec"/>

Figure 28: Video & Audio Settings Page

2. View the audio selection mode and the current selection.

Audio selection mode is viewed.

Enabling Audio Only

KIT-401T enables passing only the audio signal via the embedded webpages.

To enable/disable audio only:

1. In the Navigation pane, click **Video & Audio Settings**. The Video & Audio Settings page appears (see [Figure 28](#)).
2. Click **Enabled** to enable audio only; and click **Disabled** for AV switching.

Audio only mode is set.

Setting HDCP Support

Enable or disable HDCP support for the HDMI input on the KIT-401T.

To enable/disable HDCP support on the HDMI input:

1. In the Navigation pane, click **Video & Audio Settings**. The Video & Audio page appears (see [Figure 28](#)).
2. Click **Enabled** next to Local HDMI IN 1, to enable HDCP support or **Disabled** to disable HDCP support.

HDCP support is set.

Setting Audio and Video Timeouts

KIT-401T enables setting the video and audio timeout settings via the embedded webpages.

To set the video / audio timeouts:

1. In the Navigation pane, click **Video and Audio Settings**. The Video & Audio Settings page appears (see [Figure 28](#)).
2. Set the timeout in seconds for delaying:
 - Switching upon signal loss when 5V power is left on.
 - Switching in case a cable is unplugged.
3. Click **Set Timeout**.

Video and audio timeouts are set.

Defining Receiver Settings

KIT-401T enables quickly setting up KIT-400R via the embedded webpages.

To set KIT-400R parameters:

1. In the Navigation pane, click **Quick Receiver Setup**. The Video & Audio Settings page appears.

The screenshot shows the 'Quick Receiver Setup' page with a 'Factory reset' button in the top right. The page is organized into several sections, each with a title and a row of buttons:

- Set HDBT EDID:** Buttons for 1080P, 4K30, 4K60 4:2:0, and Output.
- Set HDMI EDID:** Buttons for 1080P, 4K30, 4K60 4:2:0, 4K60 4:4:4, and Output.
- Set Output Resolution:** Buttons for 1080P, 4K30, 4K60 4:2:0, and Native.
- Set Aspect Ratio:** Buttons for Best Fit and Full.
- Set HDCP:** Buttons for Enable on HDMI Input, Disable on HDMI Input, Enable on HDBT Input, and Disable on HDBT Input.

Figure 29: Quick Receiver Setup Page

2. Perform the following actions on **KIT-400R**:
 - Select the HDBT input EDID.
 - Select the HDMI input EDID.
 - Set the HDMI output resolution.
 - Set the output aspect ratio.
 - Enable or disable HDCP support on the HDBT and HDMI inputs.



The selected button momentarily turns blue.

KIT-400R basic parameters are set.

Configuring Device Automation

Use the Automation page to access **Kramer Maestro** V1.5 room automation. **Maestro** is a powerful tool that enables you to configure single-trigger room element automation scenarios without the need for complicated programming. To use room automation, you need to define triggers that, upon an event, will execute scripts which include a sequence of actions (commands, which can appear in different scenarios) that will be carried out via any defined ports.

Download the **Kramer Maestro** User Manual from the Kramer web site at www.kramerav.com/downloads/KIT-401 to learn how to use **Kramer Maestro**.



Note that all the ports, actions and triggers that are relevant to **KIT-401** are included in the **Kramer Maestro**, as well as ports, actions and triggers that are relevant to other Kramer devices.



The Panel tab in the Automation page is currently unavailable.

This section describes the following actions:

- [Accessing Kramer Maestro](#) on page [45](#).
- [Disabling Auto-Switching](#) on page [45](#).

Accessing Kramer Maestro

KIT-401T enables accessing Kramer Maestro via the embedded webpages.

To access Kramer Maestro:

1. In the Navigation pane, click **Automation**. The Maestro page appears.

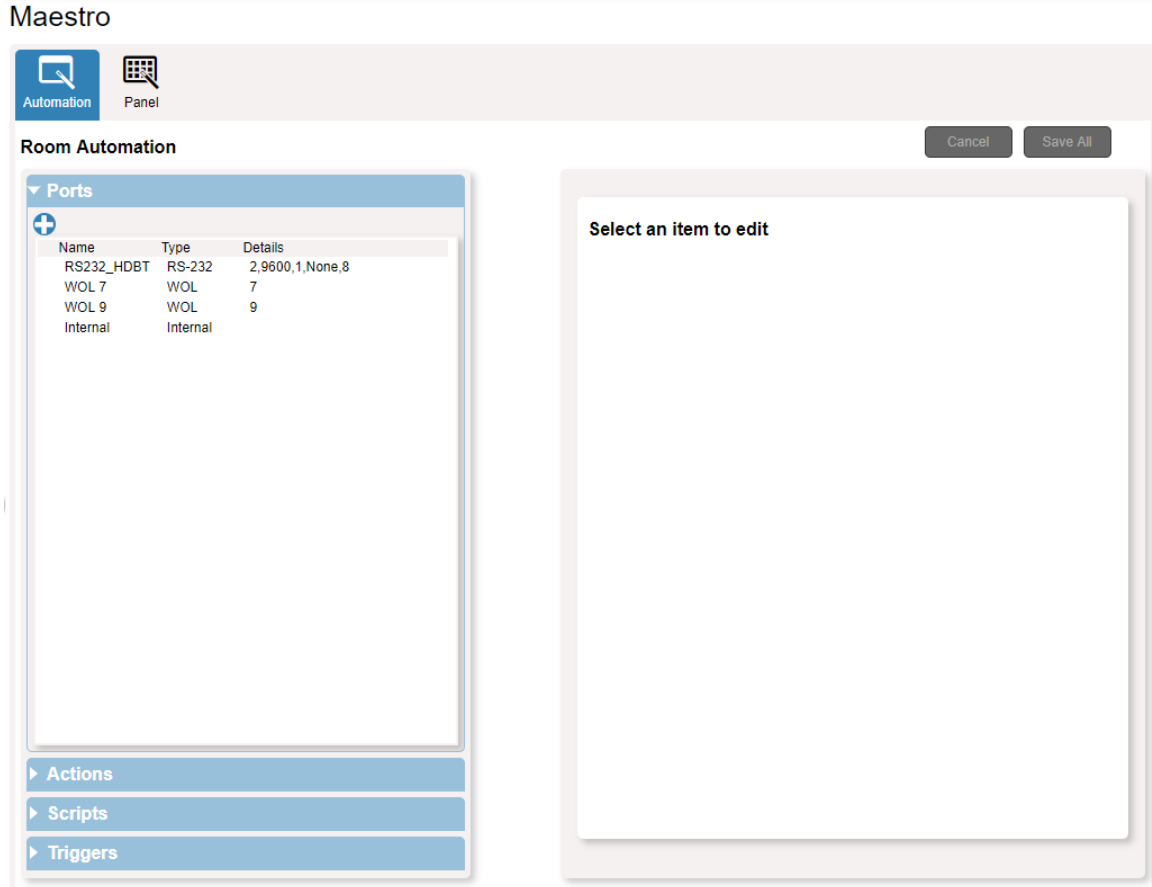

Figure 30: Automation Page

2. Configure the ports, actions, scripts and triggers, as described in the Kramer Maestro User Manual.



The baud-rate for the RS232_HDBT port is 9600.

Once the triggers are defined, the trigger activates the scripts configured in the automation page. For example, when using the Scheduling trigger, you can activate a series of actions following a preset schedule.

Disabling Auto-Switching

By default, KIT-401T is configured for Last-Connected auto-switching. You can disable the auto-switching via the embedded webpages.

To disable the auto-switching:

1. In the Navigation pane, click **Automation**. The Automation page appears (see [Figure 30](#)).

2. Click **Triggers**. The Triggers area opens. The Triggers area lists 4 default triggers.

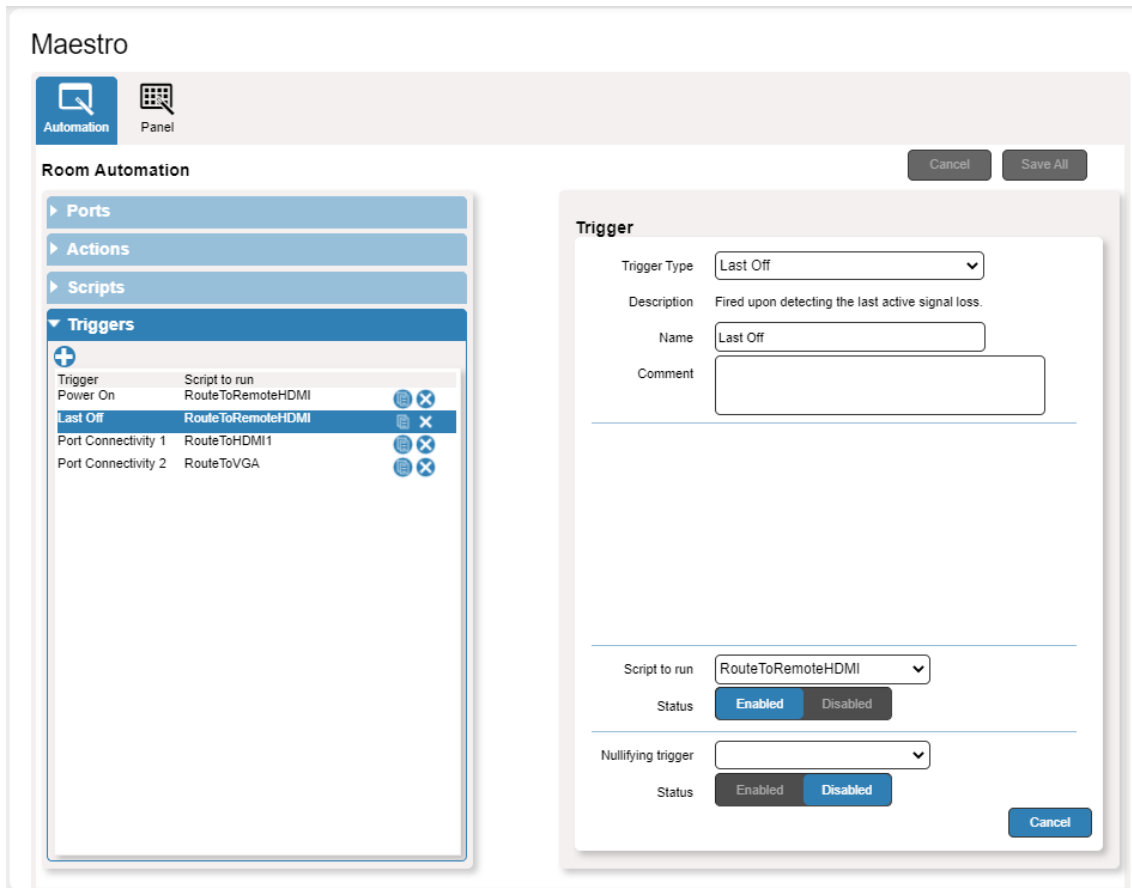

Figure 31: [Figure Caption]

3. Select **Last Off** trigger.
4. In the Trigger area, next to Script to run, click **Disabled**.
5. Repeat the last 2 steps for the next two triggers:
 - Port Connectivity 1.
 - Port Connectivity 2.
6. Click **Save All**.



We recommend keeping the Power On trigger.

7. On the **KIT-401T** rear panel, set both video DIP-switches 1 and 2 to ON (down), (see [Setting KIT-401T DIP-switches](#) on page 14).
 8. Power-cycle the device.
- Auto-switching is disabled.

Enabling Auto Switching

If the auto-switching was disabled (for example, by following the procedure described above), you can enable it once again.

To enable the auto-switching:

1. On the **KIT-401T** rear panel, set both video DIP-switches 1 and 2 to Off (up), (see [Setting KIT-401T DIP-switches](#) on page 14).
 2. Power-cycle the device.
 3. In the Navigation pane click **Device Settings** and perform Factory reset (see [Performing a Factory Reset](#) on page 34).
 4. In the Navigation pane, click **Automation**. The Automation page appears (see [Figure 30](#)).
 5. Click **Triggers**. The Triggers area opens.
 6. Select **Last Off** trigger.
 7. In the Trigger area, next to Script to run, click **Enabled**.
 8. Repeat the last 2 steps for the next two triggers:
 - Port Connectivity 1.
 - Port Connectivity 2.
 9. Click **Save All**.
 10. Make sure all 4 default triggers are enabled.
 11. On the **KIT-401T** rear panel, set both video DIP-switches 1 and 2 to OFF (up) (see [Setting KIT-401T DIP-switches](#) on page 14).
 12. Power-cycle the device.
- Auto-switching is enabled.

Operating via Room Automation Panel

You can control **KIT-401** via any of Kramer's touch panels (for example, **KT-1010**) which include the **Kramer Aware** app.

KIT-401 enables performing the following actions:

- Viewing and carrying out actions via the control panel in the Automation Page.
- Editing the device control panel.

Viewing and Executing Actions Via Device Control Panel

Before connecting to a designated touch panel, you can view the default control panel and ensure the buttons are active and are suited for your needs.

To view and execute actions via the control panel:

1. In the Navigation pane, click **Automation**. The Automation page appears (see [Figure 30](#)).
2. Click the **Panel** tab (by-default, in Action mode). The default **KIT-401** Device Control Panel appears.

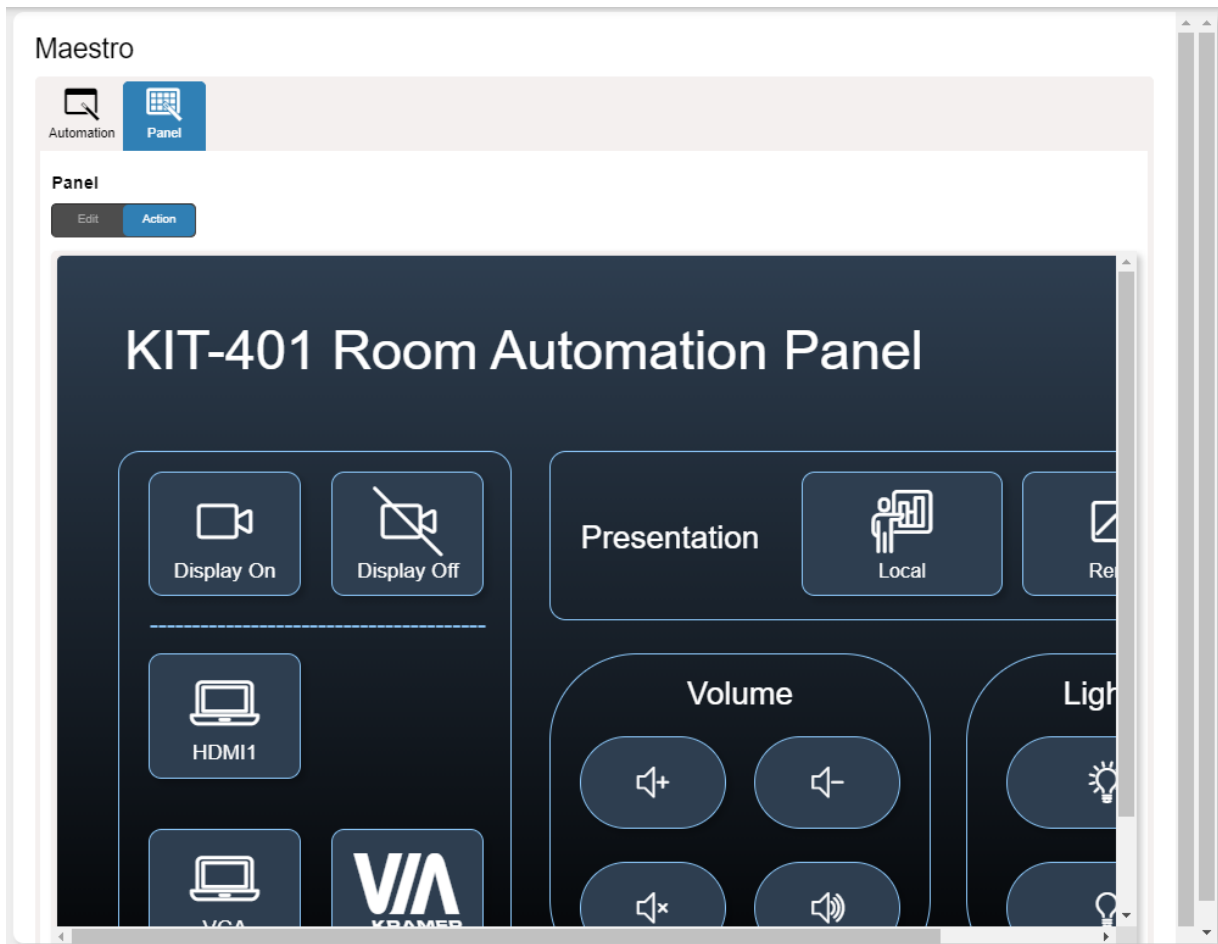

Figure 32:Automation Page – Panel Tab



The resolution of the panel fits the designated touch-panel, therefore it appears in large-scale.

3. Perform the following actions:
 - Click **All Off** to turn the device on/off.
 - Click **Display On / Display Off** to send a CEC command to the display on the **KIT-400R**.
 - Click **HDMI 1**, **VGA** and so on, to select an input.
 - Click any of the default available buttons, as needed.

KIT-401 panel is viewed, and the relevant commands are carried out.

Configuring the Device Control Panel

The default device control panel items can be configured to suit your needs. Each item on the panel can be modified and new items can be added. The Edit Panel window includes a display of the current device control panel, the properties area to the right, the Object List below and three Add buttons to add new items to the panel next to the Object List.

The **KIT-401T** Device Panel Control Panel enables performing the following actions:

- [Selecting Panel Model](#) on page [50](#).
- [Setting the Panel Background](#) on page [51](#).
- [Defining Panel Configuration Grid](#) on page [51](#).
- [Modifying a Button](#) on page [51](#).
- [Modifying Text](#) on page [53](#).
- [Modifying a Frame](#) on page [55](#).
- [Adding a New Button](#) on page [56](#).
- [Adding a New Text Field](#) on page [58](#).
- [Adding a New Frame](#) on page [59](#).

Selecting Panel Model

To select the panel model:

1. In the Navigation pane, click **Automation**. The Automation page appears (see [Figure 30](#)).
2. Click the **Panel** tab. The default **KIT-401** Device Control Panel appears (see [Figure 32](#)).
3. Click **Edit**. Edit Panel window appears, showing the General Properties area.



You can also access General Properties by clicking the background panel area.

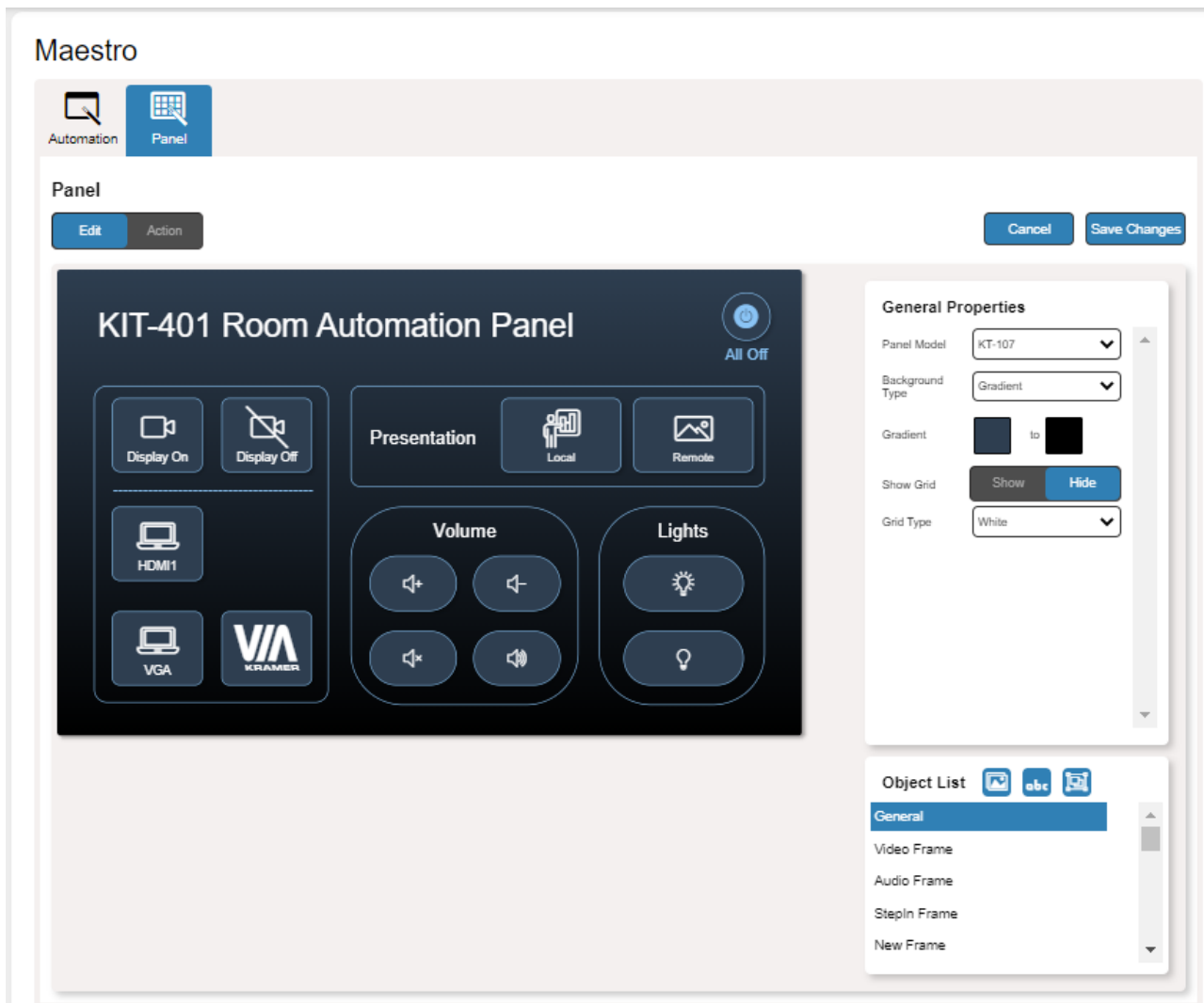

Figure 33: Automation Page – Editing Panel Window

4. From Panel Model drop-down list (in General Properties), define the panel model. If **Custom** is selected, set Panel Size (in pixels).
5. Click **Save Changes**.

Panel model is defined.

Setting the Panel Background

You can select the background color and configure the background pattern.

To configure the panel background:

1. In the Navigation pane, click **Automation**. The Automation page appears (see [Figure 30](#)).
2. Click the **Panel** tab. The default **KIT-401** Device Control Panel appears (see [Figure 32](#)).
3. Click **EDIT**. Edit Panel window appears (see [Figure 33](#)).
4. In General Properties area set the Background Type:
 - **Solid** – Click Background Color button to select the color.
 - **Gradient** – Click Gradient color buttons to select the gradient.
 - **Pattern** – Select the pattern colors, type, and sizes.
 - **Image** – Click Upload Image button to select an image file.

Defining Panel Configuration Grid

The background grid helps align each configured item in the panel. You can show and hide the grid and select its color for your convenience.

To define the grid:

1. In the Navigation pane, click **Automation**. The Automation page appears (see [Figure 30](#)).
2. Click the **Panel** tab. The default **KIT-401** Device Control Panel appears (see [Figure 32](#)).
3. Click **EDIT**. Edit Panel window appears (see [Figure 33](#)).
4. Click **Show** to show grid.
5. From Grid Type drop-down box, select the grid color.

The configuration grid is defined.

Modifying a Button

The default device control panel includes several buttons (for example, the Volume Up button) that can be modified.

To modify a button:

1. In the Navigation pane, click **Automation**. The Automation page appears (see [Figure 30](#)).
2. Click the **Panel** tab. The **KIT-401** Device Control Panel appears (see [Figure 32](#)).
3. Click **EDIT**. Edit Panel window appears (see [Figure 33](#)).

- Click the relevant button (in this example, **VolumeUp** appears in the Object List).
Volume Up button is selected in the device control panel.



Figure 34: Edit Panel – Volume Up button Selected

The Properties (Button) and VolumeUp Object list appear:

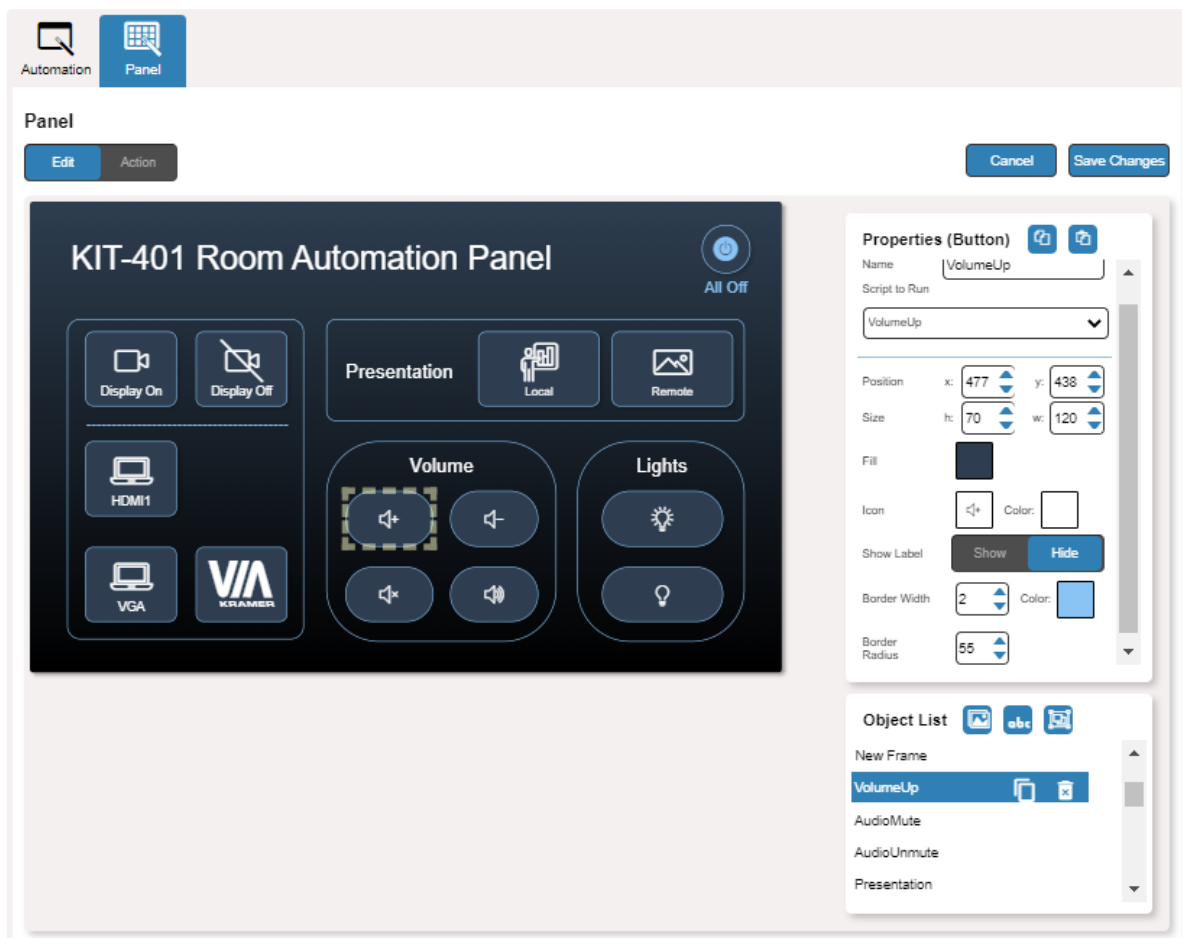





Figure 35: Edit Panel – Properties (Button) Area

- Next to VolumeUp, do any of the following:
 - Click  to remove the button.
 - Click  to duplicate the button.

6. In the Properties (Button) area, perform any of the following actions:
 - Click  to copy the selected button properties (Fill, Icon Color, Label Size and Color, Border Color, Border Width and Color, and Border Radius).
 - Click  to paste button properties to a selected frame.
 - Change the button name.
 - Select the script to run when this button is pressed.
 - Set the position of the button by moving the button (or by entering the x, y position).
 - Enter button Size to change h and w button size (or use up/down arrows).
 - Click the Fill color button to change the button color.
 - Change the button Icon and select its Color.
 - Click **Show/Hide** to show or hide the frame.
 - Enter Border Width to change the button border width (or use up/down arrows).
 - Click border Color button to select border color.
 - Enter Border Radius to change the border edge radius (or use up/down arrows).
7. Click **Save Changes**.

This button is configured.

Modifying Text

The default control panel includes Text (for example, Presentation). You can modify a button, using the Panel Edit tab.

To modify the text:

1. In the Navigation pane, click **Automation**. The Automation page appears (see [Figure 30](#)).
2. Click the **Panel** tab. The **KIT-401** Device Control Panel appears (see [Figure 32](#)).
3. Click **EDIT**. Edit Panel window appears (see [Figure 33](#)).
(In this example, VolumeUp appears in the Object List).
4. Click the relevant Text Field, for example, Presentation (in this example, **newTextField** appears in the Object List).

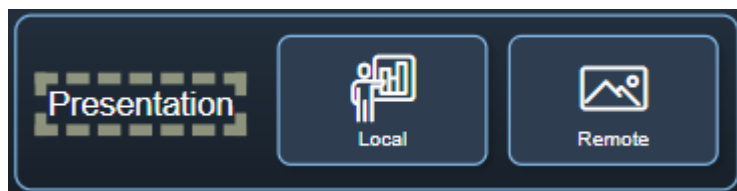

Figure 36: Edit Panel – Text Field Selected

The Properties (Text Field) and NewTextField Object list appear:

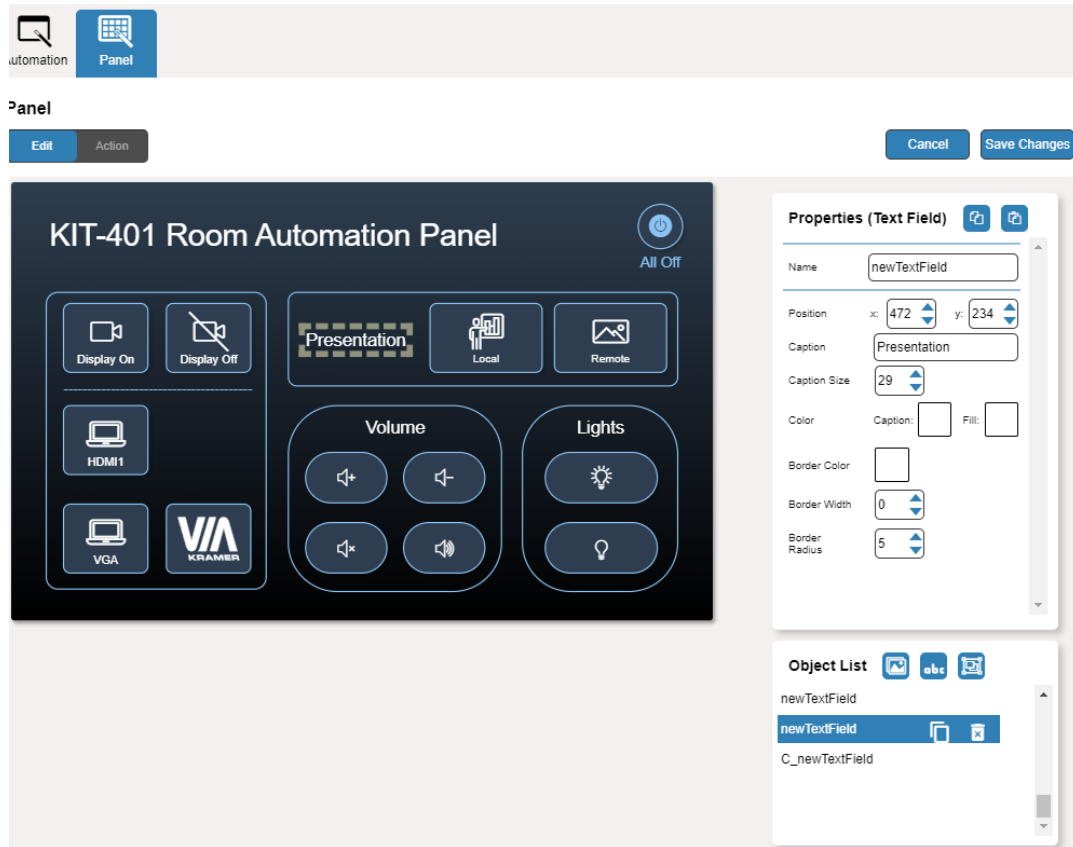





Figure 37: Edit Panel – Properties (Text Field) Area

5. Next to newTextField, do any of the following:
 - Click  to remove the text field.
 - Click  next to duplicate the text field.
6. In the Properties (Text Field) area, perform any of the following actions:
7. Perform any of the following actions:
 - Click  to copy the selected text field properties (Caption Size, Caption and Fill Color, Border Width and Color, and Border Radius).
 - Click  to paste button properties to a selected Text Field.
 - Change the text field name.
 - Set the position of the button by moving the button (or by entering the x, y position).
 - Enter the caption.
 - Enter Caption Size (or use up/down arrows).
 - Click the Caption and Fill colors to change them.
 - Change the button Icon and select its Color.
 - Click Border Color button to select border color.
 - Enter Border Width to change the border width (or use up/down arrows).
 - Enter Border Radius to change the border edge radius (or use up/down arrows).

8. Click **Save Changes**.

Presentation text field is configured.

Modifying a Frame

The default device control panel includes several frames (for example, the Video Frame) that can be modified via the Edit Panel tab.

To modify a frame:

1. In the Navigation pane, click **Automation**. The Automation page appears (see [Figure 30](#)).
2. Click the **Panel** tab. The **KIT-401 Device Control Panel** appears (see [Figure 32](#)).
3. Click **EDIT**. Edit Panel window appears (see [Figure 33](#)).
4. Click the relevant frame (in this example, **Video Frame** appears in the Object List). Video frame is selected in the control panel.



Figure 38: Edit Panel – Video Frame Selected

The Properties (Frame) and Video Frame Object list appear:

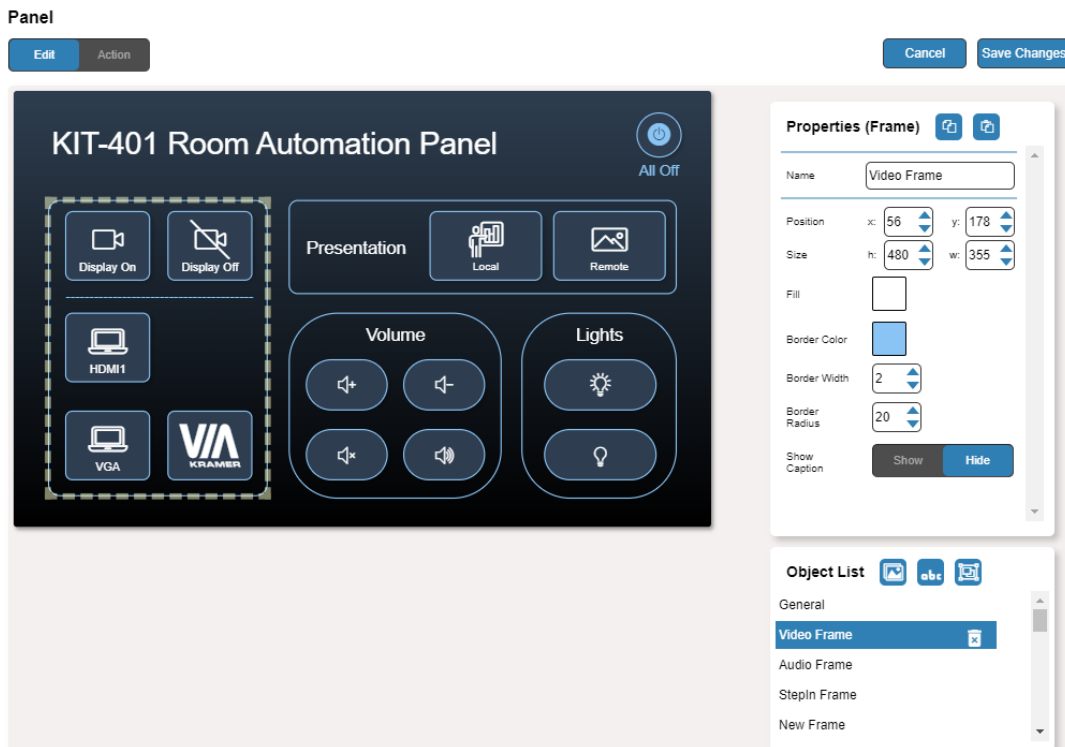





Figure 39: Edit Panel – Properties (Button) Area

5. Click  next to Video Frame to remove the frame from the panel.
6. In the Properties (Frame) area, perform any of the following actions:
 - Click  to copy the selected frame properties (Fill, Border Color, Border Width and Border Radius).
 - Click  to paste frame properties to a selected frame.
 - Change the frame Name.
 - Set the position of the frame by moving it (or by entering the x, y coordinates).
 - Enter frame size (or click Size up/down arrows to change h and w frame size).
 - Click the Fill color button to change the frame color.
 - Click the Border Color button to change the border color.
 - Enter Border Width to change the border width (or use up/down arrows).
 - Enter Border Radius to change the border edge radius (or use up/down arrows).
 - Click **Show/Hide** to show or hide the frame.
7. Click **Save Changes**.

The frame is configured.

Adding a New Button

The buttons in the device control panel are designed to carry out an assigned script to run when that button is pressed.

To add a new button:

1. In the Navigation pane, click **Automation**. The Automation page appears (see [Figure 30](#)).
2. Click the **Panel** tab. The default **KIT-401** Device Control Panel appears (see [Figure 32](#)).
3. Click **EDIT**. The Edit panel appears (see [Figure 33](#)).

- Click  (add a button object) to add a new button to the panel. A new button is added to the top left side of the panel.

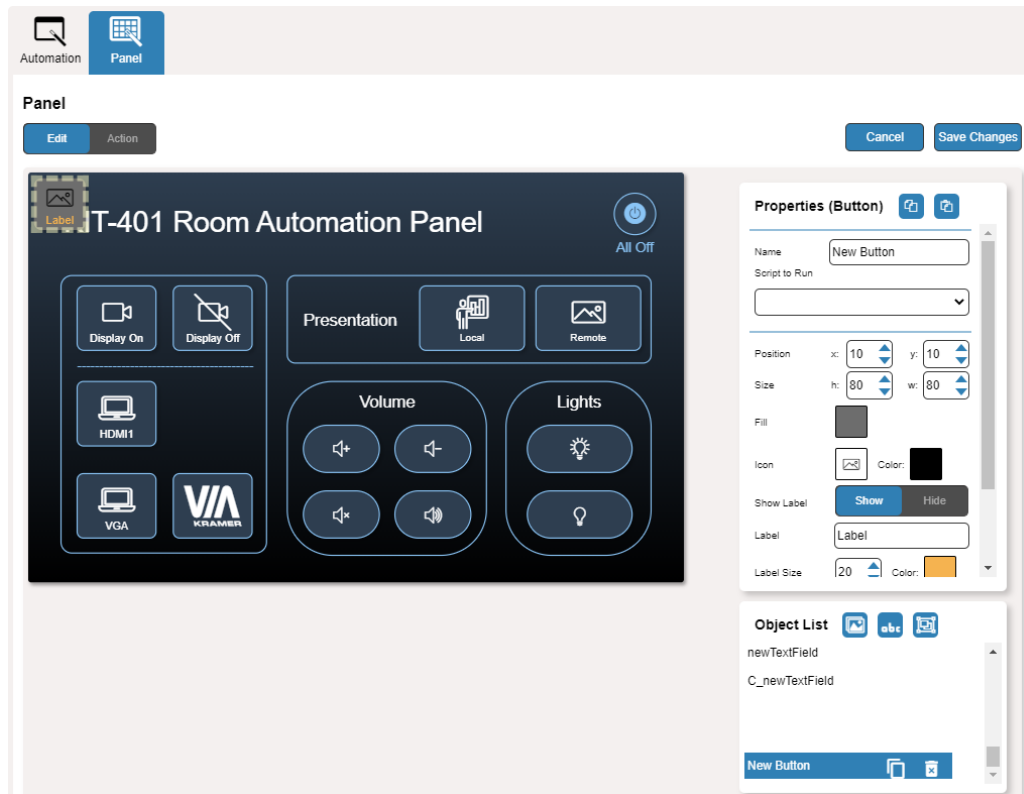

Figure 40: Adding a new Button

- Enter the button name. For example, use “Meeting Off” to turn off the devices in the room when a meeting ends.
- Assign a script (for example, **MeetingOFF**) to this button from the drop-down list.

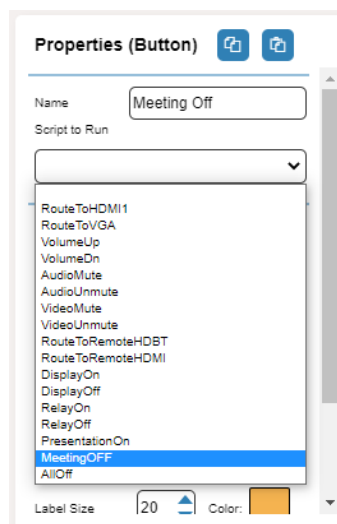

Figure 41: New Button – Assigning a Script

- Design the button appearance by selecting the button:
 - Position and size.
 - Background fill.
 - Icon and icon color.

8. Click **Show/Hide** to show or hide the button.
When showing the Caption, define label text, size and color.
 9. Enter the Label, label size and color.
 10. Define the border width, color and radius.
 11. Click **Save Changes**.
- A new button is added.

Adding a New Text Field

The Text Field in the device control panel is designed to give a title to a group of buttons.

To add a new text field:

1. In the Navigation pane, click **Automation**. The Automation page appears (see [Figure 30](#)).
2. Click the **Panel** tab. The default **KIT-401** Device Control Panel appears (see [Figure 32](#)).
3. Click **EDIT**. The Edit panel appears (see [Figure 33](#)).
4. Click  (add a text field) to add a new text field to the panel. A new text field is added to the top left side of the panel.

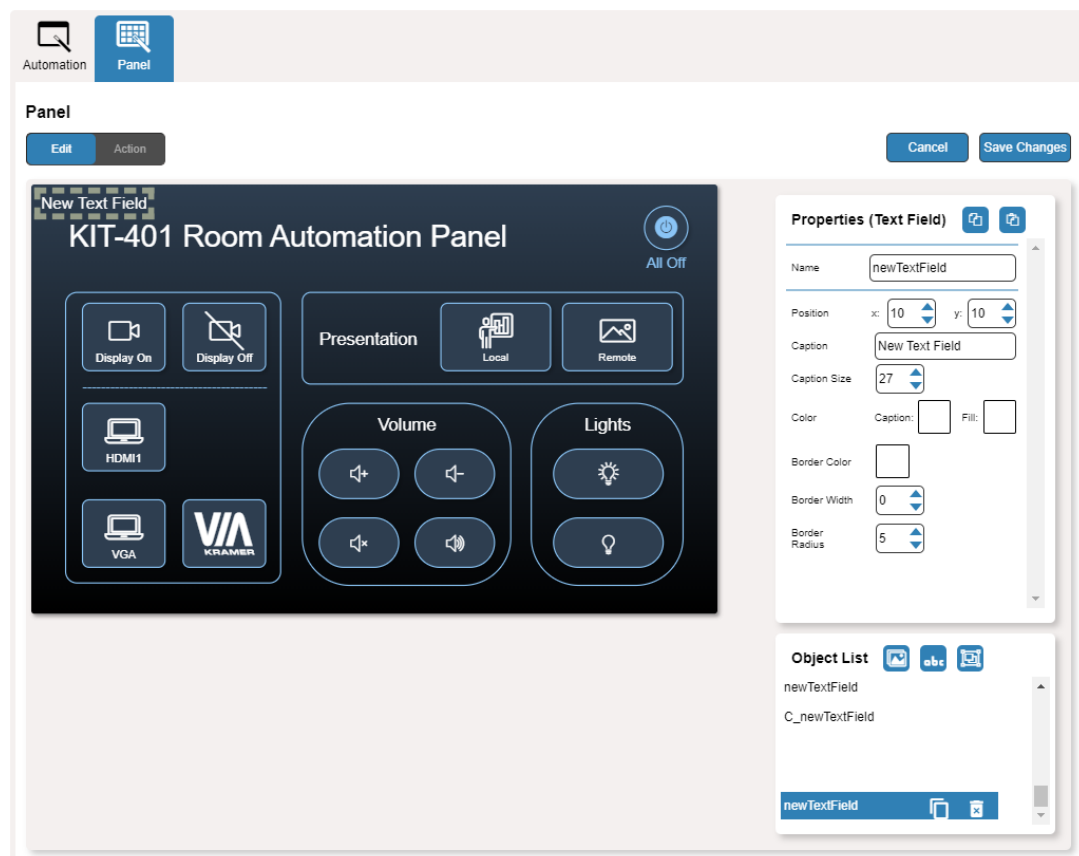

Figure 42: Adding a new Text Field

5. Enter the text field name. For example, use “Meeting Space” to define meetings on/off area.
6. Enter the text caption.

7. Design the text field appearance by selecting its:

- Position and size.
- Caption color and background fill.
- Border width, color and radius.

8. Click **Save Changes**.

A new text field is added.

Adding a New Frame

The frame in the device control panel is designed to encircle a group of buttons.

To add a new frame:

1. In the Navigation pane, click **Automation**. The Automation page appears (see [Figure 30](#)).
2. Click the **Panel** tab. The default **KIT-401** Device Control Panel appears (see [Figure 32](#)).
3. Click **EDIT**. The Edit panel appears (see [Figure 33](#)).
4. Click  (add a frame) to add a new frame to the panel. A new frame is added to the top left side of the panel.

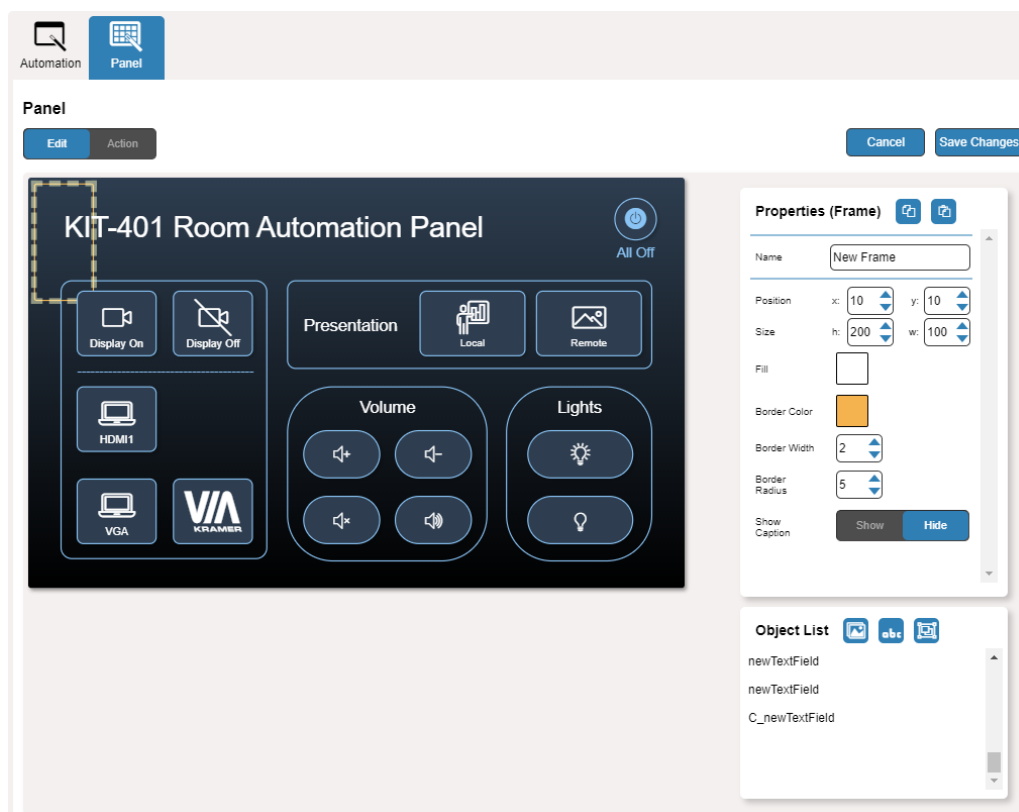

Figure 43: Adding a new Frame

5. Enter the frame name. For example, use “Meeting frame” to define meetings on/off area.

6. Design the frame appearance by selecting its:
 - Position and size.
 - Border color and background fill.
 - Border width and radius.
 7. Click **Show/Hide** to show or hide the frame. When showing the Caption, define:
 - Caption text and size.
 - Caption text color, background color and border color.
 - Caption offset.
 8. Click **Save Changes**.
- A new frame is added.

Managing EDID

You can copy EDID to any of the inputs in any of the following ways:

- [Copying EDID from an Output](#) on page [61](#).
- [Copying EDID from an Input](#) on page [64](#).
- [Copying Default EDID](#) on page [66](#).
- [Loading a Custom EDID File](#) on page [66](#).

You can also load a customized EDID file from your PC.

The selected EDID can be copied to the selected input/s.



View the currently selected EDID source Bytemap by clicking **Bytemap** on the right side.

Copying EDID from an Output

To copy an EDID from an output to an input:

1. In the Navigation pane, click **EDID Management**. The EDID Management page appears.

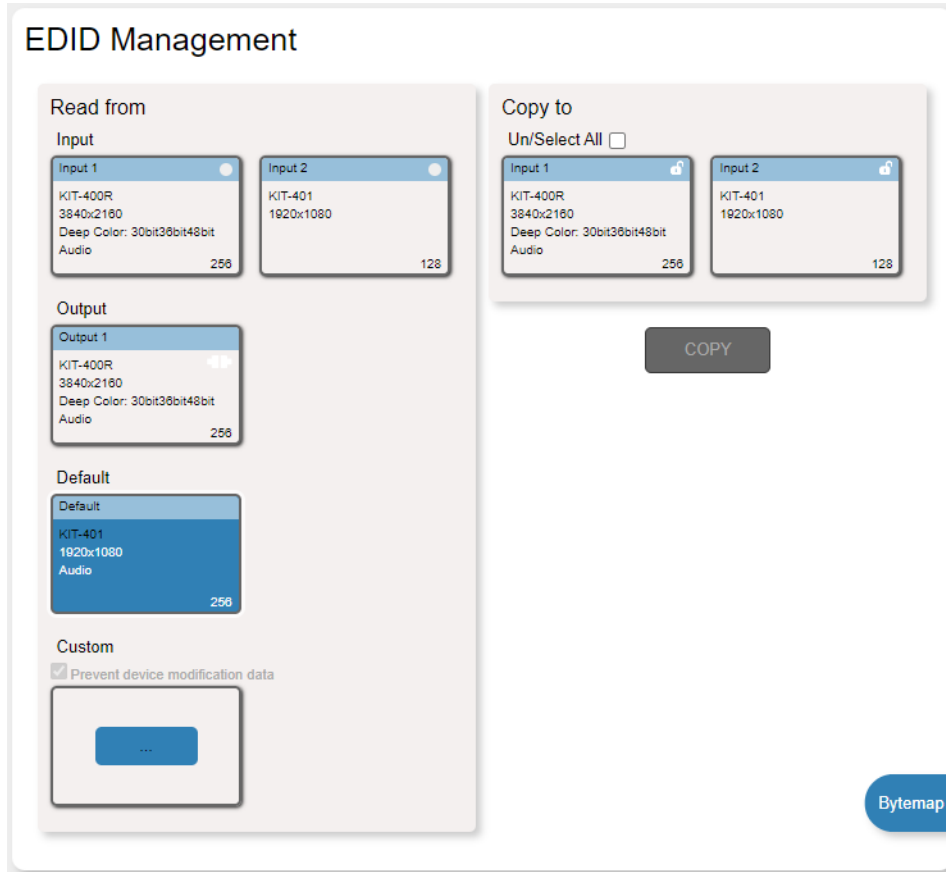

Figure 44: EDID Management Page

2. Under Read from, select Output 1 if not selected.



Make sure that that output is connected to an acceptor.

3. Select the input/s (or all the inputs) to which the EDID is to be copied (for example, Input 1 and Input 2).

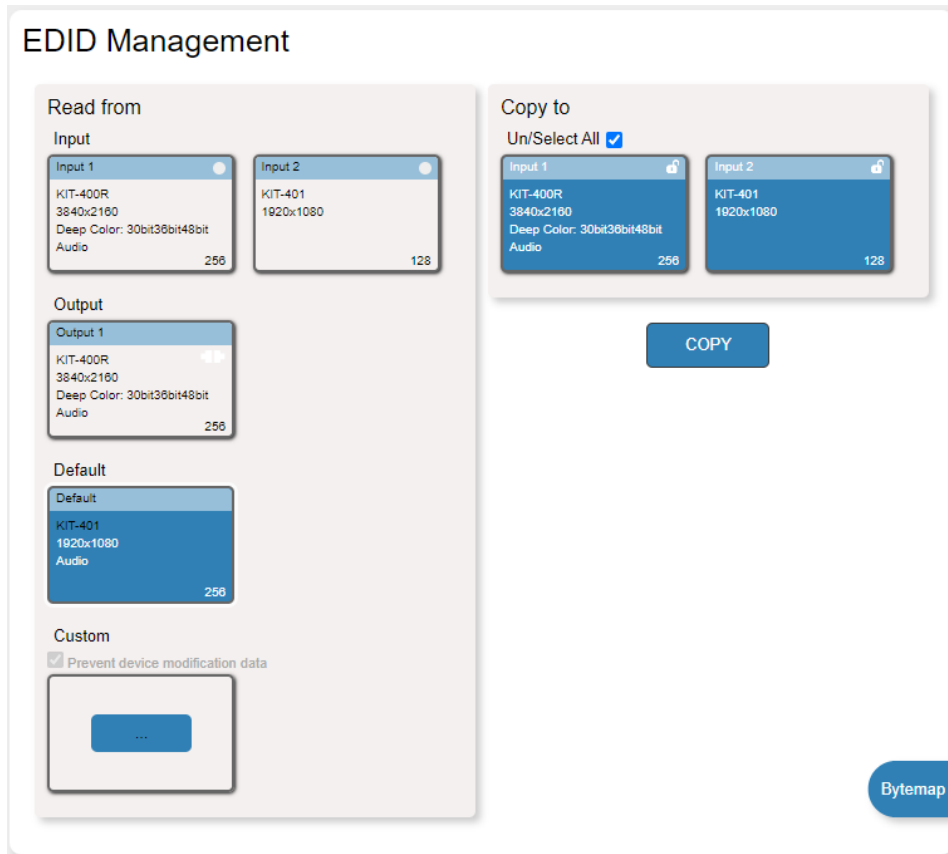

Figure 45: EDID Management Page – Select the Inputs (Copy to)

4. Click **COPY**.
The Output 1 EDID is copied to the selected inputs.

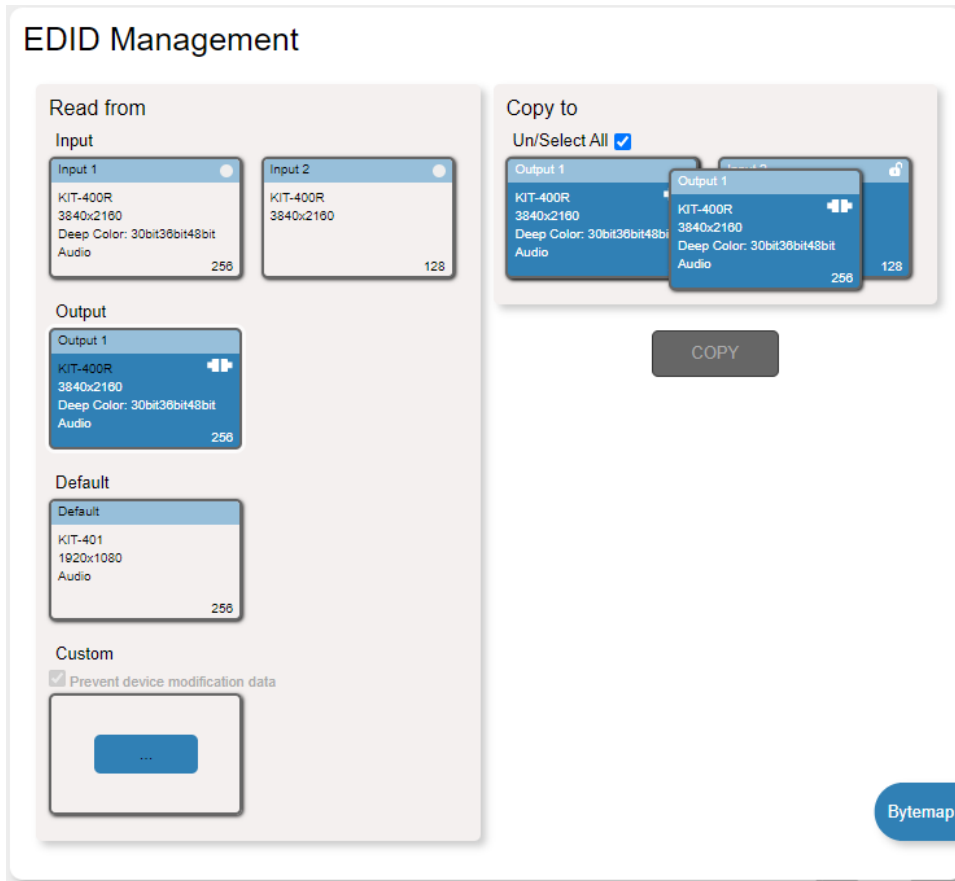

Figure 46: EDID Management Page – EDID Copied from Output

EDID is copied from the output to the selected input/s.

Copying EDID from an Input

To copy an EDID from an input to an input:

1. In the Navigation pane, click **EDID Management**. The EDID Management page appears (see [Figure 44](#)).
2. Under Read from Input, select an input (for example, Input 1).

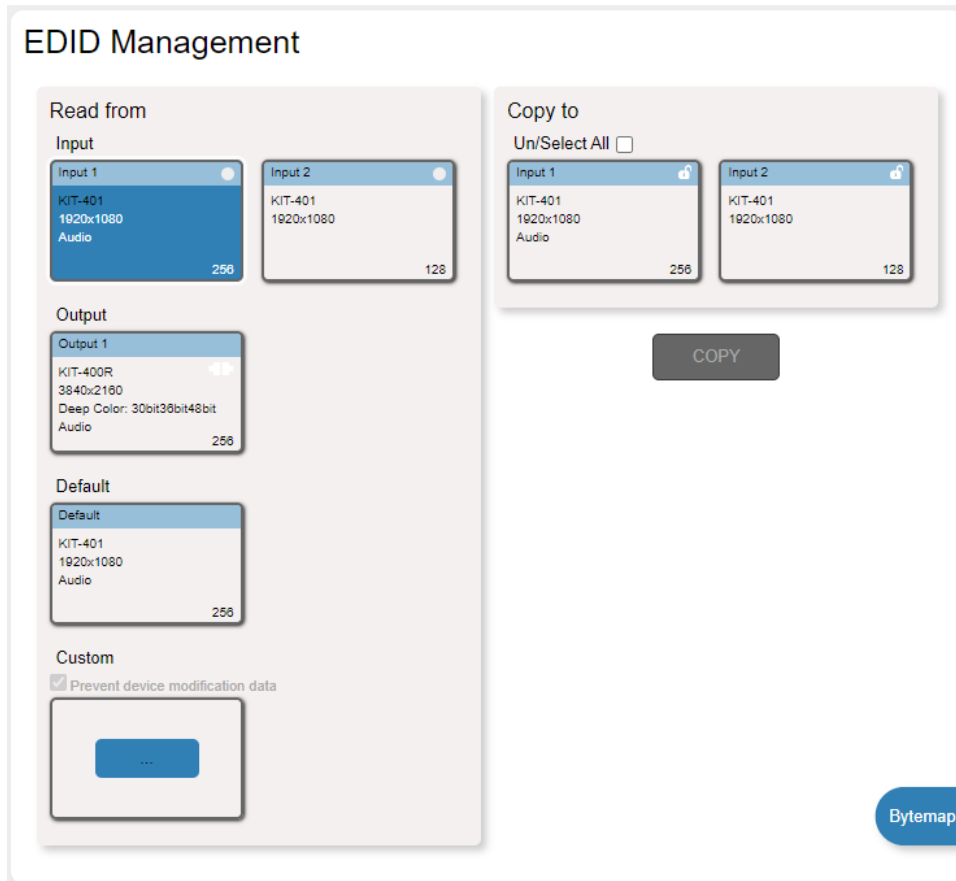

Figure 47: EDID Management Page – Copy from Input

3. Select the input/s to which the EDID is to be copied (for example, Input 2).

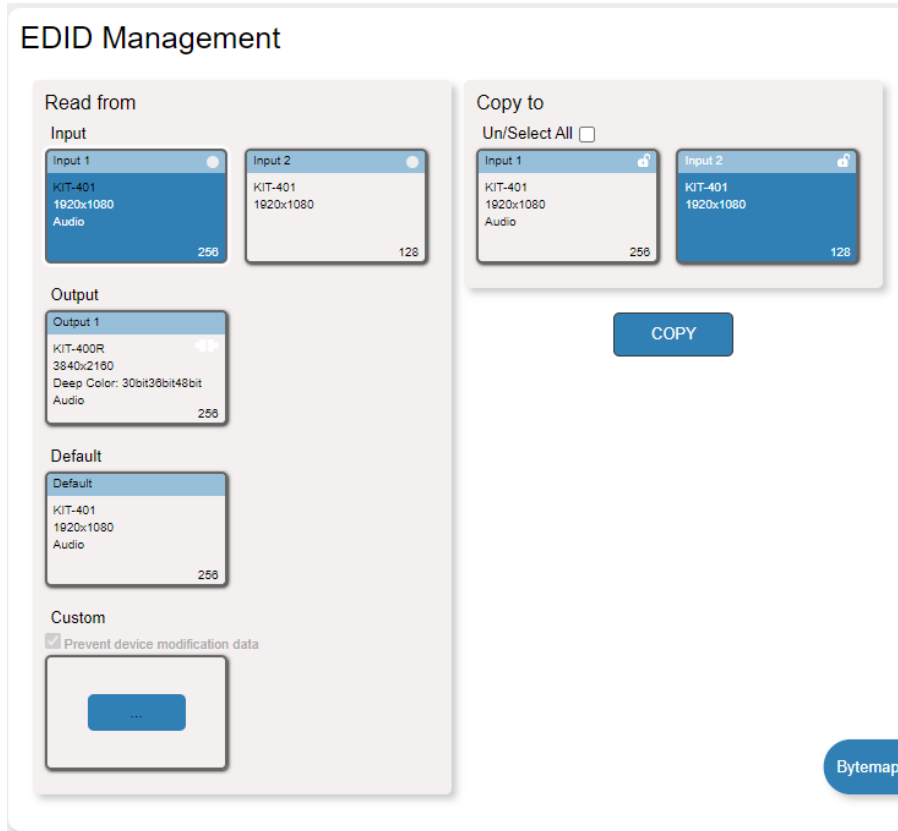

Figure 48: EDID Management Page – Select an EDID Input (Read From)

4. Click **COPY**.

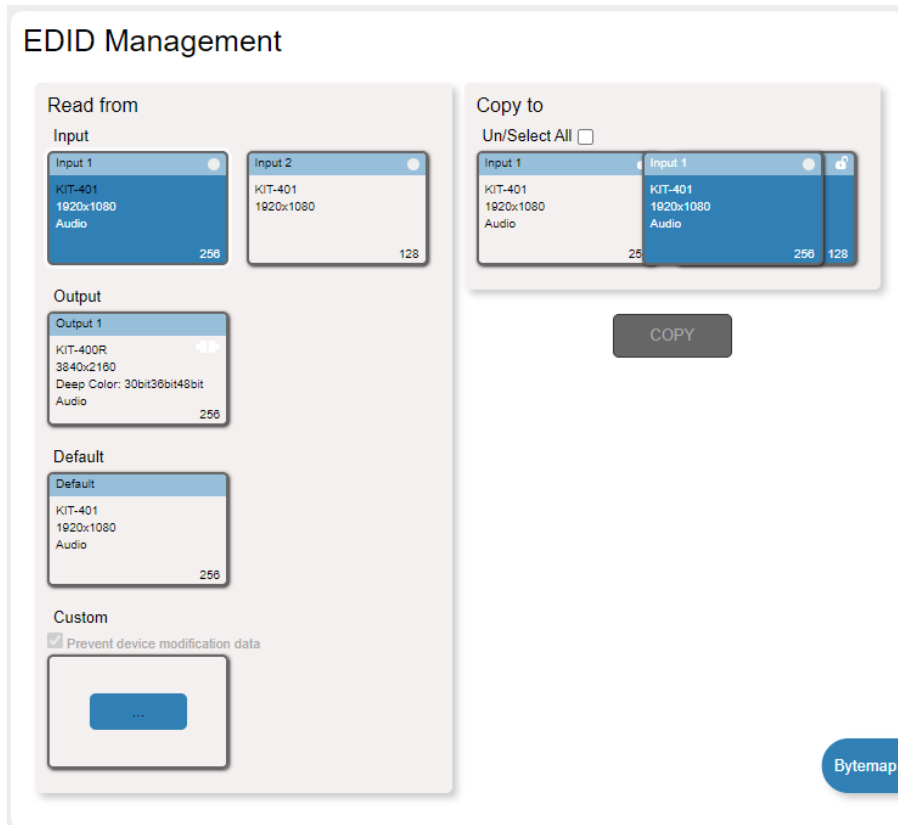

Figure 49: EDID Management Page – EDID Copied from Input

EDID is copied from a selected input to the selected input/s.

Copying Default EDID

To read the EDID from the default EDID:

1. In the Navigation pane, click **EDID**. The EDID Management page appears (see [Figure 44](#)).
2. Click **Default**.
3. Select the input/s (or all the inputs) to which the default EDID is to be copied.
4. Click **Copy** and follow the instructions on-screen.

Default EDID is copied to the selected inputs.

Loading a Custom EDID File

To load a custom EDID file:

1. In the Navigation pane, click **EDID**. The EDID Management page appears (see [Figure 44](#)).
2. In the **File** area click custom button.
3. Select the EDID file.
4. Select the input/s (or all the inputs) to which the EDID is copied.
5. Click **Copy** and follow the instructions on-screen.

Custom EDID is copied to the selected inputs.

Viewing About Page

The **KIT-401T** About page lets you view the Webpage version and Kramer Electronics Ltd details.



Figure 50: About Page

Upgrading Firmware

This section describes the following update procedures:

- [Upgrading KIT-401T](#) on page [67](#).
- [Upgrading KIT-400R](#) on page [67](#).

Upgrading KIT-401T

Upgrade KIT-401T via:

- The KIT-401T webpages (see [Upgrading the Firmware](#) on page [37](#)).
- K-UPLOAD software ([Upgrading KIT-401T via K-UPLOAD](#) on page [67](#)).

Upgrading KIT-401T via K-UPLOAD

Use the Kramer K-UPLOAD software to upgrade the firmware via the KIT-401T PROG micro USB port ① or via Ethernet.

The latest version of K-UPLOAD and installation instructions can be downloaded from our website at: www.kramerav.com/support/product_downloads.asp.



Note that in order to use the micro USB port, you need to install the Kramer USB driver, available at: www.kramerav.com/support/product_downloads.asp.

Upgrading KIT-400R

KIT-400R can be upgraded via a memory stick.

To upgrade KIT-400R firmware:

1. Save the new firmware xxx.bin file to the parent directory on a memory stick.



The memory stick should only include this file.

2. Power the device.
3. Make sure that a display is connected to the device.
4. Plug the memory stick into the PROG USB port on the device front panel.
5. Press and hold both the MENU button and the ENTER button until input LEDs flash and then release.
Firmware upgrade is now in process. During upgrade, the LEDs flash and once complete, one of the INPUT LEDs turns on and a signal bar appears on the output.
6. Check that the OSD Information screen shows the latest FW version.
7. In the OSD, go to FACTORY menu, press **ENTER**, select RESET ALL and press **ENTER** again.

KIT-400R is updated.

Technical Specifications

KIT-401T		
Inputs	1 HDMI	On female HDMI connector
	1 VGA	On a 15-pin HD connector
	1 Unbalanced Stereo Audio	On a 3.5mm mini jack
Outputs	1 HDBaseT	On an RJ-45 connector
	1 Unbalanced Stereo Audio	On a 3.5mm mini jack
Ports	1 Ethernet	On an RJ-45 connector
	1 Control RS-232	On a 3-pin terminal block connector
	1 Data RS-232	On a 3-pin terminal block connector
	1 Remote Contact-Closure	On a 4-pin terminal block connector
	1 Service USB	On a mini-USB connector for firmware upgrade
KIT-400R		
Inputs	1 HDBaseT	On an RJ-45 connector
	1 HDMI	On female HDMI connectors
Outputs	1 HDMI	On female HDMI connectors
	1 Balanced Audio	On a 5-pin terminal block connector
Ports	1 Control RS-232	On a 3-pin terminal block connector
	1 Data RS-232	On a 3-pin terminal block connector
	1 Remote Contact-Closure	On a 4-pin terminal block connector
	1 Relay	On a 3-pin terminal block connector
	1 Program USB	On a USB-A connector for firmware upgrade
KIT-401T and KIT-400R		
Video	Max Data Rate (on the HDMI ports)	KIT-400R: 18Gbps KIT-401T: 10.2Gbps
	Max Resolution (on HDMI ports)	KIT-400R: 4K@60Hz (4:4:4) KIT-401T: 4K@60Hz (4:2:0)
	HDMI Support	4K60, CEC, xvYCC color
	Content Protection	KIT-400R: HDCP 1.4 and 2.2 KIT-401T: HDCP 1.4
Extension Line	Up to 40m (130ft)	At 4K@60Hz (4:2:0)
	Up to 70m (230ft)	At full HD (1080p@60Hz)
Extended RS-232	Baud Rate	300 to 115200
User Interface	Controls	Input select button, DIP-switches, remote contact-closure switches, relay switches. Kramer API via RS-232 serial commands transmitted by a PC, touch screen system or other serial controller, embedded webpages via LAN for configuration and control
	Indicators	Power, link, input selection LEDs
Power	Consumption	12V DC, 2.2A
	Source	12V DC, 5A
Environmental Conditions	Operating Temperature	0° to +40°C (32° to 104°F)
	Storage Temperature	-40° to +70°C (-40° to 158°F)
	Humidity	10% to 90%, RHL non-condensing
Standards Compliance	Safety	CE, FCC
	Environmental	RoHs, WEEE

Enclosure	Size	KIT-401T: 2 Gang wall-plate KIT-400R: MegaTOOLS®
	Type	Aluminum
	Cooling	Convection Ventilation
General	Net Dimensions (W, D, H)	KIT-401T: 2 Gang (EU or US) KIT-400R: 18.8cm x 14.5cm x 2.5cm (7.38" x 5.7" x 1.00")
	Shipping Dimensions (W, D, H)	19.4cm x 27.2cm x 11.3cm (7.6" x 10.7" x 4.4")
	Net Weight	KIT-401: 0.8kg (1.8lbs)
	Shipping Weight	KIT-401: 1.7kg (3.7lbs)
Accessories	Included	1 Power adapter, cable adapter and cord, 4 rubber feet, 2 bracket sets (for KIT-400R), 1 frame or frame kit and installation accessories (for KIT-401T)
Specifications are subject to change without notice at www.kramerav.com		

Default Communication Parameters

RS-232	
Baud Rate:	115,200
Data Bits:	8
Stop Bits:	1
Parity:	None
Command Format:	ASCII
Example (route video IN 2 to video HDBT OUT):	#ROUTE_1,1,2<CR>
Ethernet	
To reset the IP settings to the factory reset values go to: Menu->Setup -> Factory Reset-> press Enter to confirm	
IP Address:	192.168.1.39
Subnet mask:	255.255.0.0
Default gateway:	192.168.0.1
Default TCP Port #:	5000
Default UDP Port #:	50000
Default username:	Admin
Default password:	Admin
Full Factory Reset	
Front panel:	There is no option for factory reset from front panel.
Protocol 3000:	"#factory" command.
Webpages:	Device Settings page, Soft Factory Reset resets all parameters to factory default except for network parameters.

KIT-400R Output Resolution Support

KIT-400R supports the following resolutions.

640x480 @60Hz	1600x1200 @60Hz	3440x1440 @30Hz	1920x1080P @50Hz
800x600 @60Hz	1680x1050 @60Hz	3440x1440 @60Hz	1920x1080P @60Hz
1024x768 @60Hz	1920x1200 @60Hz RB	720x480P @60Hz	2560x1080P @50Hz
1280x768 @60Hz	2560x1600 @60Hz RB	720x576P @50Hz	2560x1080P @60Hz
1280x800 @60Hz	1920x1080 @60Hz	1280x720P @50Hz	3840x2160P @24Hz
1280x1024 @60Hz	1280x720 @60Hz	1280x720P @60Hz	3840x2160P @25Hz
1360x768 @60Hz	2048x1080 @50Hz	1920x1080P @24Hz	3840x2160P @30Hz
1400x1050 @60Hz	2048x1080 @60Hz	1920x1080P @25Hz	3840x2160P @50Hz
1440x900 @60Hz	2560x1440 @60Hz RB	1920x1080P @30Hz	3840x2160P @60Hz

Default EDID

This section includes the:

- [KIT-401T Default EDID](#) on page [71](#).
- [KIT-400R Default EDID for HDMI](#) on page [72](#).
- [KIT-400R Default EDID for HDBT](#) on page [74](#).

KIT-401T Default EDID

Monitor

Model name..... KIT-401
 Manufacturer..... KMR
 Plug and Play ID..... KMR1200
 Serial number..... n/a
 Manufacture date..... 2015, ISO week 255
 Filter driver..... None

 EDID revision..... 1.3
 Input signal type..... Digital
 Color bit depth..... Undefined
 Display type..... RGB color
 Screen size..... 520 x 320 mm (24.0 in)
 Power management..... Standby, Suspend, Active off/sleep
 Extension blocs..... 1 (CEA-EXT)

 DDC/CI..... n/a

Color characteristics

Default color space..... Non-sRGB
 Display gamma..... 2.20
 Red chromaticity..... Rx 0.674 - Ry 0.319
 Green chromaticity..... Gx 0.188 - Gy 0.706
 Blue chromaticity..... Bx 0.148 - By 0.064
 White point (default).... Wx 0.313 - Wy 0.329
 Additional descriptors... None

Timing characteristics

Horizontal scan range... 30-83kHz
 Vertical scan range..... 56-76Hz
 Video bandwidth..... 170MHz
 CVT standard..... Not supported
 GTF standard..... Not supported
 Additional descriptors... None
 Preferred timing..... Yes
 Native/preferred timing.. 1920x1080p at 60Hz (16:10)
 Modeline..... "1920x1080" 148.500 1920 2008 2052 2200 1080 1084 1089 1125 +hsync +vsync
 Detailed timing #1..... 1280x720p at 60Hz (16:10)
 Modeline..... "1280x720" 74.250 1280 1390 1430 1650 720 725 730 750 +hsync +vsync

Standard timings supported

720 x 400p at 70Hz - IBM VGA
 720 x 400p at 88Hz - IBM XGA2
 640 x 480p at 60Hz - IBM VGA
 640 x 480p at 67Hz - Apple Mac II
 640 x 480p at 72Hz - VESA
 640 x 480p at 75Hz - VESA
 800 x 600p at 56Hz - VESA
 800 x 600p at 60Hz - VESA
 800 x 600p at 72Hz - VESA
 800 x 600p at 75Hz - VESA
 832 x 624p at 75Hz - Apple Mac II
 1024 x 768i at 87Hz - IBM
 1024 x 768p at 60Hz - VESA
 1024 x 768p at 70Hz - VESA
 1024 x 768p at 75Hz - VESA
 1280 x 1024p at 75Hz - VESA
 1152 x 870p at 75Hz - Apple Mac II
 1280 x 1024p at 75Hz - VESA STD
 1280 x 1024p at 85Hz - VESA STD
 1600 x 1200p at 60Hz - VESA STD
 1024 x 768p at 85Hz - VESA STD
 800 x 600p at 85Hz - VESA STD
 640 x 480p at 85Hz - VESA STD
 1152 x 864p at 70Hz - VESA STD
 1280 x 960p at 60Hz - VESA STD

EIA/CEA-861 Information

Revision number..... 3
 IT underscan..... Supported
 Basic audio..... Supported
 YCbCr 4:4:4..... Supported
 YCbCr 4:2:2..... Supported
 Native formats..... 1
 Detailed timing #1..... 1920x1080p at 60Hz (16:10)
 Modeline..... "1920x1080" 148.500 1920 2008 2052 2200 1080 1084 1089 1125 +hsync +vsync
 Detailed timing #2..... 1920x1080i at 60Hz (16:10)
 Modeline..... "1920x1080" 74.250 1920 2008 2052 2200 1080 1084 1094 1124 interlace +hsync +vsync
 Detailed timing #3..... 1280x720p at 60Hz (16:10)

Vertical scan range..... 23-61Hz
 Video bandwidth..... 600MHz
 CVT standard..... Not supported
 GTF standard..... Not supported
 Additional descriptors... None
 Preferred timing..... Yes
 Native/preferred timing.. 3840x2160p at 60Hz (16:9)
 Modeline..... "3840x2160" 594.000 3840 4016 4104 4400 2160 2168 2178 2250 +hsync +vsync
 Detailed timing #1..... 1920x1080p at 60Hz (16:9)
 Modeline..... "1920x1080" 148.500 1920 2008 2052 2200 1080 1084 1089 1125 +hsync +vsync

Standard timings supported

640 x 480p at 60Hz - IBM VGA
 640 x 480p at 72Hz - VESA
 640 x 480p at 75Hz - VESA
 800 x 600p at 56Hz - VESA
 800 x 600p at 60Hz - VESA
 800 x 600p at 72Hz - VESA
 800 x 600p at 75Hz - VESA
 1024 x 768p at 60Hz - VESA
 1024 x 768p at 70Hz - VESA
 1024 x 768p at 75Hz - VESA
 1280 x 1024p at 75Hz - VESA
 1600 x 1200p at 60Hz - VESA STD
 1280 x 1024p at 60Hz - VESA STD
 1400 x 1050p at 60Hz - VESA STD
 1920 x 1080p at 60Hz - VESA STD
 640 x 480p at 85Hz - VESA STD
 800 x 600p at 85Hz - VESA STD
 1024 x 768p at 85Hz - VESA STD
 1280 x 1024p at 85Hz - VESA STD

EIA/CEA-861 Information

Revision number..... 3
 IT underscan..... Supported
 Basic audio..... Supported
 YCbCr 4:4:4..... Supported
 YCbCr 4:2:2..... Supported
 Native formats..... 0
 Detailed timing #1..... 1440x900p at 60Hz (16:10)
 Modeline..... "1440x900" 106.500 1440 1520 1672 1904 900 903 909 934 -hsync +vsync
 Detailed timing #2..... 1366x768p at 60Hz (16:9)
 Modeline..... "1366x768" 85.500 1366 1436 1579 1792 768 771 774 798 +hsync +vsync
 Detailed timing #3..... 1920x1200p at 60Hz (16:10)
 Modeline..... "1920x1200" 154.000 1920 1968 2000 2080 1200 1203 1209 1235 +hsync -vsync

CE video identifiers (VICs) - timing/formats supported

1920 x 1080p at 60Hz - HDTV (16:9, 1:1)
 1920 x 1080p at 50Hz - HDTV (16:9, 1:1)
 1280 x 720p at 60Hz - HDTV (16:9, 1:1)
 1280 x 720p at 50Hz - HDTV (16:9, 1:1)
 1920 x 1080i at 60Hz - HDTV (16:9, 1:1)
 1920 x 1080i at 50Hz - HDTV (16:9, 1:1)
 720 x 480p at 60Hz - EDTV (4:3, 8:9)
 720 x 576p at 50Hz - EDTV (4:3, 16:15)
 720 x 480i at 60Hz - Doublescan (4:3, 8:9)
 720 x 576i at 50Hz - Doublescan (4:3, 16:15)
 1920 x 1080p at 30Hz - HDTV (16:9, 1:1)
 1920 x 1080p at 25Hz - HDTV (16:9, 1:1)
 1920 x 1080p at 24Hz - HDTV (16:9, 1:1)
 1920 x 1080p at 24Hz - HDTV (16:9, 1:1)
 1920 x 1080p at 24Hz - HDTV (16:9, 1:1)
 1920 x 1080p at 24Hz - HDTV (16:9, 1:1)
 1920 x 1080p at 24Hz - HDTV (16:9, 1:1)
 1920 x 1080p at 24Hz - HDTV (16:9, 1:1)
 NB: NTSC refresh rate = (Hz*1000)/1001

CE audio data (formats supported)

LPCM 2-channel, 16/20/24 bit depths at 32/44/48 kHz

CE speaker allocation data

Channel configuration.... 2.0
 Front left/right..... Yes
 Front LFE..... No
 Front center..... No
 Rear left/right..... No
 Rear center..... No
 Front left/right center.. No
 Rear left/right center... No
 Rear LFE..... No

CE vendor specific data (VSDB)

IEEE registration number. 0x00C03
 CEC physical address..... 1.0.0.0
 Supports AI (ACP, ISRC).. No
 Supports 48bpp..... Yes
 Supports 36bpp..... Yes
 Supports 30bpp..... Yes
 Supports YCbCr 4:4:4..... Yes
 Supports dual-link DVI... No
 Maximum TMDS clock..... 300MHz
 Audio/video latency (p).. n/a
 Audio/video latency (i).. n/a
 HDMI video capabilities.. Yes
 EDID screen size..... No additional info
 3D formats supported..... Not supported
 Data payload..... 030C001000783C20008001020304

CE vendor specific data (VSDB)
 IEEE registration number. 0xC45DD8
 CEC physical address..... 0.1.7.8
 Supports AI (ACP, ISRC).. Yes
 Supports 48bpp..... No
 Supports 36bpp..... No
 Supports 30bpp..... No
 Supports YCbCr 4:4:4..... No
 Supports dual-link DVI... No
 Maximum TMDS clock..... 35MHz

Reserved video related data
 Data payload..... 0F000003

Report information
 Date generated..... 11/3/2020
 Software revision..... 2.60.0.972
 Data source..... File - NB: improperly installed
 Operating system..... 6.2.9200.2

Raw data
 00,FF,FF,FF,FF,FF,FF,FF,00,2D,B2,0D,06,31,00,00,00,06,1C,01,03,80,24,24,8C,C2,90,20,9C,54,50,8F,26,
 21,52,56,2F,CF,00,A9,40,81,80,90,40,D1,C0,31,59,45,59,61,59,81,99,08,E8,00,30,F2,70,5A,80,B0,58,
 8A,00,BA,88,21,00,00,1E,02,3A,80,18,71,38,2D,40,58,2C,45,00,BA,88,21,00,00,1E,00,00,00,FC,00,4B,
 49,54,2D,34,30,30,52,0A,20,20,20,20,00,00,00,FD,00,17,3D,0F,88,3C,00,0A,20,20,20,20,20,01,E1,
 02,03,3B,F0,52,10,1F,04,13,05,14,02,11,06,15,22,21,20,5D,5E,5F,60,61,23,09,07,07,83,01,00,00,6E,
 03,0C,00,10,00,78,3C,20,00,80,01,02,03,04,67,D8,5D,C4,01,78,80,07,E4,0F,00,00,03,9A,29,A0,D0,51,
 84,22,30,50,98,36,00,10,0A,00,00,00,1C,66,21,56,AA,51,00,1E,30,46,8F,33,00,10,09,00,00,00,1E,28,
 3C,80,A0,70,B0,23,40,30,20,36,00,10,0A,00,00,00,1A,00,00,00,00,00,00,00,00,00,00,00,00,00,E0

KIT-400R Default EDID for HDBT

Monitor
 Model name..... KIT-400R
 Manufacturer..... KMR
 Plug and Play ID..... KMR031D
 Serial number..... 49
 Manufacture date..... 2018, ISO week 6
 Filter driver..... None

 EDID revision..... 1.3
 Input signal type..... Digital
 Color bit depth..... Undefined
 Display type..... Monochrome/grayscale
 Screen size..... 360 x 360 mm (20.0 in)
 Power management..... Standby, Suspend, Active off/sleep
 Extension blocs..... 1 (CEA-EXT)

 DDC/CI..... n/a

Color characteristics
 Default color space..... Non-sRGB
 Display gamma..... 2.40
 Red chromaticity..... Rx 0.611 - Ry 0.329
 Green chromaticity..... Gx 0.313 - Gy 0.559
 Blue chromaticity..... Bx 0.148 - By 0.131
 White point (default).... Wx 0.320 - Wy 0.336
 Additional descriptors... None

Timing characteristics
 Horizontal scan range... 15-136kHz
 Vertical scan range..... 23-61Hz
 Video bandwidth..... 300MHz
 CVT standard..... Not supported
 GTF standard..... Not supported

Additional descriptors... None
 Preferred timing..... Yes
 Native/preferred timing.. 3840x2160p at 30Hz (16:9)
 Modeline..... "3840x2160" 297.000 3840 4016 4104 4400 2160 2168 2178 2250 +hsync +vsync
 Detailed timing #1..... 1920x1080p at 60Hz (16:9)
 Modeline..... "1920x1080" 148.500 1920 2008 2052 2200 1080 1084 1089 1125 +hsync +vsync

Standard timings supported

640 x 480p at 60Hz - IBM VGA
 640 x 480p at 72Hz - VESA
 640 x 480p at 75Hz - VESA
 800 x 600p at 56Hz - VESA
 800 x 600p at 60Hz - VESA
 800 x 600p at 72Hz - VESA
 800 x 600p at 75Hz - VESA
 1024 x 768p at 60Hz - VESA
 1024 x 768p at 70Hz - VESA
 1024 x 768p at 75Hz - VESA
 1280 x 1024p at 75Hz - VESA
 1600 x 1200p at 60Hz - VESA STD
 1280 x 1024p at 60Hz - VESA STD
 1400 x 1050p at 60Hz - VESA STD
 1920 x 1080p at 60Hz - VESA STD
 640 x 480p at 85Hz - VESA STD
 800 x 600p at 85Hz - VESA STD
 1024 x 768p at 85Hz - VESA STD
 1280 x 1024p at 85Hz - VESA STD

EIA/CEA-861 Information

Revision number..... 3
 IT underscan..... Supported
 Basic audio..... Supported
 YCbCr 4:4:4..... Supported
 YCbCr 4:2:2..... Supported
 Native formats..... 0
 Detailed timing #1..... 1440x900p at 60Hz (16:10)
 Modeline..... "1440x900" 106.500 1440 1520 1672 1904 900 903 909 934 -hsync +vsync
 Detailed timing #2..... 1366x768p at 60Hz (16:9)
 Modeline..... "1366x768" 85.500 1366 1436 1579 1792 768 771 774 798 +hsync +vsync
 Detailed timing #3..... 1920x1200p at 60Hz (16:10)
 Modeline..... "1920x1200" 154.000 1920 1968 2000 2080 1200 1203 1209 1235 +hsync -vsync

CE video identifiers (VICs) - timing/formats supported

1920 x 1080p at 60Hz - HDTV (16:9, 1:1)
 1920 x 1080p at 50Hz - HDTV (16:9, 1:1)
 1280 x 720p at 60Hz - HDTV (16:9, 1:1)
 1280 x 720p at 50Hz - HDTV (16:9, 1:1)
 1920 x 1080i at 60Hz - HDTV (16:9, 1:1)
 1920 x 1080i at 50Hz - HDTV (16:9, 1:1)
 720 x 480p at 60Hz - EDTV (4:3, 8:9)
 720 x 576p at 50Hz - EDTV (4:3, 16:15)
 720 x 480i at 60Hz - Doublescan (4:3, 8:9)
 720 x 576i at 50Hz - Doublescan (4:3, 16:15)
 1920 x 1080p at 30Hz - HDTV (16:9, 1:1)
 1920 x 1080p at 25Hz - HDTV (16:9, 1:1)
 1920 x 1080p at 24Hz - HDTV (16:9, 1:1)
 1920 x 1080p at 24Hz - HDTV (16:9, 1:1)
 1920 x 1080p at 24Hz - HDTV (16:9, 1:1)
 1920 x 1080p at 24Hz - HDTV (16:9, 1:1)
 NB: NTSC refresh rate = (Hz*1000)/1001

CE audio data (formats supported)

LPCM 2-channel, 16/20/24 bit depths at 32/44/48 kHz

CE speaker allocation data

Channel configuration.... 2.0
 Front left/right..... Yes
 Front LFE..... No
 Front center..... No
 Rear left/right..... No
 Rear center..... No
 Front left/right center.. No
 Rear left/right center... No
 Rear LFE..... No

CE vendor specific data (VSDB)

IEEE registration number. 0x000C03
 CEC physical address.... 1.0.0.0
 Supports AI (ACP, ISRC).. No
 Supports 48bpp..... Yes
 Supports 36bpp..... Yes
 Supports 30bpp..... Yes

Supports YCbCr 4:4:4..... Yes
 Supports dual-link DVI... No
 Maximum TMDS clock..... 300MHz
 Audio/video latency (p).. n/a
 Audio/video latency (i).. n/a
 HDMI video capabilities.. Yes
 EDID screen size..... No additional info
 3D formats supported..... Not supported
 Data payload..... 030C001000783C20008001020304

Reserved video related data
 Data payload..... 0E6160

Report information
 Date generated..... 11/3/2020
 Software revision..... 2.60.0.972
 Data source..... File - NB: improperly installed
 Operating system..... 6.2.9200.2

Raw data
 00,FF,FF,FF,FF,FF,FF,00,2D,B2,1D,03,31,00,00,00,06,1C,01,03,80,24,24,8C,E2,90,20,9C,54,50,8F,26,
 21,52,56,2F,CF,00,A9,40,81,80,90,40,D1,C0,31,59,45,59,61,59,81,99,04,74,00,30,F2,70,5A,80,B0,58,
 8A,00,BA,88,21,00,00,1E,02,3A,80,18,71,38,2D,40,58,2C,45,00,BA,88,21,00,00,1E,00,00,00,FC,00,4B,
 49,54,2D,34,30,30,52,0A,20,20,20,20,00,00,00,FD,00,17,3D,0F,88,1E,00,0A,20,20,20,20,20,01,4A,
 02,03,30,F0,50,10,1F,04,13,05,14,02,11,06,15,22,21,20,5D,5E,5F,23,09,07,07,83,01,00,00,6E,03,0C,
 00,10,00,78,3C,20,00,80,01,02,03,04,E3,0E,61,60,9A,29,A0,D0,51,84,22,30,50,98,36,00,10,0A,00,00,
 00,1C,66,21,56,AA,51,00,1E,30,46,8F,33,00,10,09,00,00,00,1E,28,3C,80,A0,70,B0,23,40,30,20,36,00,
 10,0A,00,00,00,1A,00,52

Protocol 3000

- [Understanding Protocol 3000](#) on page [77](#).
- [Protocol 3000 Commands](#) on page [78](#).
- [Result and Error Codes](#) on page [94](#).

Kramer devices can be operated using Kramer Protocol 3000 commands sent via serial or Ethernet ports.

Understanding Protocol 3000

Protocol 3000 commands are a sequence of ASCII letters, structured according to the following.

- **Command format:**

Prefix	Command Name	Constant (Space)	Parameter(s)	Suffix
#	Command	_	Parameter	<CR>

- **Feedback format:**

Prefix	Device ID	Constant	Command Name	Parameter(s)	Suffix
~	nn	@	Command	Parameter	<CR><LF>

- **Command parameters** – Multiple parameters must be separated by a comma (,). In addition, multiple parameters can be grouped as a single parameter using brackets ([and]).
- **Command chain separator character** – Multiple commands can be chained in the same string. Each command is delimited by a pipe character (|).
- **Parameters attributes** – Parameters may contain multiple attributes. Attributes are indicated with pointy brackets (<...>) and must be separated by a period (.)

The command framing varies according to how you interface with **KIT-401**. The following figure displays how the # command is framed using terminal communication software (such as Hercules):

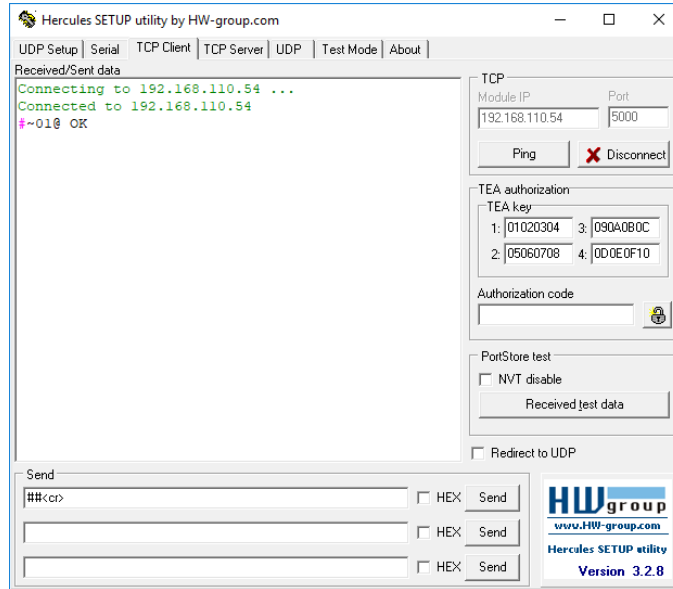

Protocol 3000 Commands

This section includes the:

- [KIT-401T Protocol Commands](#) on page 78.
- [KIT-400R Protocol Commands](#) on page 87.

KIT-401T Protocol Commands

Function	Description	Syntax	Parameters/Attributes	Example
#	Protocol handshaking. ⓘ Validates the Protocol 3000 connection and gets the machine number. Step-in master products use this command to identify the availability of a device.	COMMAND #<CR> FEEDBACK ~nn@_ok<CR><LF>		#<CR>
AUD-EMB?	Get audio in video embedding status.	COMMAND #AUD-EMB?_in_index,out_index<CR> FEEDBACK ~nn@AUD-EMB_in_index,out_index,emb_mode<CR><LF>	in_index – Number that indicates the specific input: 1– IN 1 2– IN 2 out_index – Number that indicates the specific output: 1– HDBT OUT emb_mode – Embedding status 0– Analog 1– Embedded	Get IN 1 audio embedding status: #AUD-EMB?_1,1<CR>
AUD-LVL	Set volume level.	COMMAND #AUD-LVL?_io_mode,io_index,vol_level<CR> FEEDBACK ~nn@AUD-LVL_io_mode,io_index,vol_level<CR><LF>	io_mode – Input/Output 1– Output io_index – Number that indicates the specific input or output port: 1– AUDIO OUT vol_level – Volume level -83db to 24dB; ++ (increase current value by 1dB); -- (decrease current value by 1dB)	Set AUDIO OUT level to -50dB: #AUD-LVL?_1,1,-50<CR>
AUD-LVL?	Get volume level.	COMMAND #AUD-LVL?_io_mode,io_index<CR> FEEDBACK ~nn@AUD-LVL_io_mode,io_index,vol_level<CR><LF>	io_mode – Input/Output 1– Output io_index – Number that indicates the specific input or output port: 1– AUDIO OUT vol_level – Volume level -83db to 24dB; ++ (increase current value by 1dB); -- (decrease current value by 1dB)	Get AUDIO OUT level #AUD-LVL?_1,1<CR>

Function	Description	Syntax	Parameters/Attributes	Example
AUD-LVL-RANGE?	Get audio level min and max range. ⓘ In most devices min and max audio level is a function of HW implementation and the SET command is usually not implemented.	COMMAND #AUD-LVL-RANGE?_io_mode,io_index<CR> FEEDBACK ~nn@AUD-LVL-RANGE_io_mode,io_index,min_vol,max_vol<CR><LF>	io_mode – Input/Output 1– Output io_index – Number that indicates the specific output port: 1 min_vol – -83dB max_vol – 24dB audio level	Get audio level min and max range for output 1 channel 2: #AUD-LVL-RANGE?_1,2<CR>
AUD-ONLY	Enable/disable audio only mode.	COMMAND #AUD-ONLY_channel,mode<CR> FEEDBACK ~nn@AUD-ONLY_channel,mode<CR><LF>	channel –Output 1– Output mode –audio only mode: 0– Off 1– On	Set audio only state to off: #AUD-ONLY_1,0<CR>
AUD-ONLY?	Get audio only state.	COMMAND #AUD-ONLY?_channel<CR> FEEDBACK ~nn@AUD-ONLY_channel,mode<CR><LF>	channel –Output 1– Output mode –audio only mode: 0– Off 1– On	Get audio only state #AUD-ONLY?_1<CR>
AUD-SIGNAL?	Get audio input signal status.	COMMAND #AUD-SIGNAL?_in_index<CR> FEEDBACK ~nn@AUD-SIGNAL_in_index,status<CR><LF>	in_index – Number that indicates the specific input: 1– IN 1 status – On/Off 0– Off (no signal) 1– On (signal present)	Get the status of input 1: #AUD-SIGNAL?_1<CR>
AV-SW-MODE?	Get input auto switch mode.	COMMAND #AV-SW-MODE?_layer,output_id<CR> FEEDBACK ~nn@AV-SWITCH-MODE_layer,output_id,mode<CR><LF>	layer –Layer enumeration: 1– Video 2– Audio Output_id – 1 mode – 0– manual 1– priority switch 2– last connected switch	Get the input audio switch mode: # AV-SW-MODE?_1,1<CR>
AV-SW-TIMEOUT	Set auto switching timeout.	COMMAND #AV-SW-TIMEOUT_switching_mode,time_out<CR> FEEDBACK ~nn@AV-SW-TIMEOUT_switching_mode,time_out<CR><LF>	switching_mode – Switching mode 0 – Video signal lost 2 – Audio signal lost 4 – Disable 5V on video output if no input signal detected 5 – Video cable unplugged 6 – Audio cable unplugged time_out – Timeout in seconds 0 - 60000	Set the auto switching timeout to 5 seconds in the event of 5V disable when no input signal is detected: #AV-SW-TIMEOUT_4,5<CR>
AV-SW-TIMEOUT?	Get auto switching timeout.	COMMAND #AV-SW-TIMEOUT?_switching_mode<CR> FEEDBACK ~nn@AV-SW-TIMEOUT_switching_mode,time_out<CR><LF>	switching_mode – Switching mode 0 – Video signal lost 2 – Audio signal lost 4 – Disable 5V on video output if no input signal detected 5 – Video cable unplugged 6 – Audio cable unplugged time_out – Timeout in seconds 0 - 60000	Get the Disable 5V on video output if no input signal detected timeout: #AV-SW-TIMEOUT?_4<CR>
BEACON-INFO?	Get beacon information, including IP address, UDP control port, TCP control port, MAC address, model, name. ⓘ There is no Set command. Get command initiates a notification.	COMMAND #BEACON-INFO?_port_id<CR> FEEDBACK ~nn@BEACON-INFO_port_id,ip_string,udp_port,tcp_port,mac_address,model,name<CR><LF>	port_id – ID of the Ethernet port ip_string – Dot-separated representation of the IP address udp_port – UDP control port tcp_port – TCP control port mac_address – Dash-separated mac address model – Device model name – Device name	Get beacon information: #BEACON-INFO?_<CR>
BUILD-DATE?	Get device build date.	COMMAND #BUILD-DATE?_<CR> FEEDBACK ~nn@BUILD-DATE_date,time<CR><LF>	date – Format: YYYY/MM/DD where YYYY = Year MM = Month DD = Day time – Format: hh:mm:ss where hh = hours mm = minutes ss = seconds	Get the device build date: #BUILD-DATE?<CR>

Function	Description	Syntax	Parameters/Attributes	Example
CPEDID	<p>Copy EDID data from the output to the input EEPROM.</p> <p>i Destination bitmap size depends on device properties (for 64 inputs it is a 64-bit word).</p> <p>Example: bitmap 0x0013 means inputs 1,2 and 5 are loaded with the new EDID.</p> <p>In certain products Safe_mode is an optional parameter. See the HELP command for its availability.</p>	<p>COMMAND</p> <pre>#CPEDID_<edid_io>,<src_id>,<edid_io>,<dest_bitmap><CR></pre> <p>or</p> <pre>#CPEDID_<edid_io>,<src_id>,<edid_io>,<dest_bitmap>,<safe_mode><CR></pre> <p>FEEDBACK</p> <pre>~nn@CPEDID_<edid_io>,<src_id>,<edid_io>,<dest_bitmap><CR><LF></pre> <pre>~nn@CPEDID_<edid_io>,<src_id>,<edid_io>,<dest_bitmap>,<safe_mode><CR><LF></pre>	<p>edid_io – EDID source type (usually output)</p> <p>0– Input 1– Output 2– Default EDID</p> <p>src_id – Number of chosen source stage for input source:</p> <p>1– IN 1 2– IN 2 3– IN 3</p> <p>for output source:</p> <p>1– HDBT OUT</p> <p>for default source:</p> <p>0– Default EDID source</p> <p>edid_io – EDID destination type (usually input)</p> <p>0– Input 1– Output 2– Default EDID</p> <p>dest_bitmap – Bitmap representing destination IDs. Format: XXXX...X, where X is hex digit. The binary form of every hex digit represents corresponding destinations.</p> <p>0– indicates that EDID data is not copied to this destination. 1– indicates that EDID data is copied to this destination.</p> <p>safe_mode – Safe mode</p> <p>0– device accepts the EDID as is without trying to adjust 1– device tries to adjust the EDID (default value if no parameter is sent)</p>	<p>Copy the EDID data from the HDBT OUT (EDID source) to the Input: #CPEDID_1,1,0,0x1<CR></p> <p>Copy the EDID data from the default EDID source to the Input: #CPEDID_2,0,0,0x1<CR></p>
DISPLAY?	Get output HPD status.	<p>COMMAND</p> <pre>#DISPLAY?_<out_index><CR></pre> <p>FEEDBACK</p> <pre>~nn@DISPLAY_<out_index>,<status><CR><LF></pre>	<p>out_index – Number that indicates the specific output:</p> <p>1– HDBT OUT</p> <p>status – HPD status according to signal validation</p> <p>0– Signal or sink is not valid 1– Signal or sink is valid 2– Sink and EDID is valid</p>	Get the HDBT OUT HPD status of Output 1: #DISPLAY?_1<CR>
DPSW-STATUS?	Get the DIP-switch state.	<p>COMMAND</p> <pre>#DPSW-STATUS?_<dip_id><CR></pre> <p>FEEDBACK</p> <pre>~nn@DPSW-STATUS_<dip_id>,<status><CR><LF></pre>	<p>dip_id – 1 to 4 (number of DIP switches)</p> <p>1– Video switch 1 2– Video switch 2 3– Audio switch 3 4– Audio switch 4</p> <p>status – Up/down</p> <p>0– Up 1– Down</p>	get the DIP-switch 2 status: #DPSW-STATUS?_2<CR>
ETH-PORT	<p>Set Ethernet port protocol.</p> <p>i If the port number you enter is already in use, an error is returned. The port number must be within the following range: 0-(2¹⁶-1).</p>	<p>COMMAND</p> <pre>#ETH-PORT_<port_type>,<port_id><CR></pre> <p>FEEDBACK</p> <pre>~nn@ETH-PORT_<port_type>,<port_id><CR><LF></pre>	<p>port_type – TCP/UDP</p> <p>port_id – TCP/UDP port number (0– 65535)</p>	Set the Ethernet port protocol for TCP to port 12457: #ETH-PORT_0,12457<CR>
ETH-PORT?	Get Ethernet port protocol.	<p>COMMAND</p> <pre>#ETH-PORT?_<port_type><CR></pre> <p>FEEDBACK</p> <pre>~nn@ETH-PORT_<port_type>,<port_id><CR><LF></pre>	<p>port_type – TCP/UDP</p> <p>0– TCP 1– UDP</p> <p>port_id – TCP / UDP port number (0– 65535)</p>	Get the Ethernet port protocol for UDP: #ETH-PORT?_1<CR>
FACTORY	<p>Reset device to factory default configuration.</p> <p>i This command deletes all user data from the device. The deletion can take some time.</p> <p>Your device may require powering off and powering on for the changes to take effect.</p>	<p>COMMAND</p> <pre>#FACTORY<CR></pre> <p>FEEDBACK</p> <pre>~nn@FACTORY_<ok><CR><LF></pre>		Reset the device to factory default configuration: #FACTORY<CR>
FPGA-VER?	Get current FPGA version.	<p>COMMAND</p> <pre>#FPGA-VER?_<fpga_id><CR></pre> <p>FEEDBACK</p> <pre>~nn@FPGA-VER_<fpga_id>,<expected_ver>,<ver><CR><LF></pre>	<p>fpga_id – FPGA id</p> <p>expected_ver – Expected FPGA version for current firmware</p> <p>ver – Actual FPGA version</p>	Get current FPGA version: #FPGA-VER?_1<CR>

Function	Description	Syntax	Parameters/Attributes	Example
HDCP-MOD	<p>Set HDCP mode.</p> <p>ⓘ Set HDCP working mode on the device input:</p> <p>HDCP supported - HDCP_ON [default].</p> <p>HDCP not supported - HDCP OFF.</p> <p>HDCP support changes following detected sink - MIRROR OUTPUT.</p> <p>When you define 3 as the mode, the HDCP status is defined according to the connected output in the following priority: OUT 1, OUT 2. If the connected display on OUT 2 supports HDCP, but OUT 1 does not, then HDCP is defined as not supported. If OUT 1 is not connected, then HDCP is defined by OUT 2.</p>	<p>COMMAND</p> <pre>#HDCP-MOD <u>in_index</u>,mode<CR></pre> <p>FEEDBACK</p> <pre>~nn@HDCP-MOD <u>in_index</u>,mode<CR><LF></pre>	<p>in_index – Number that indicates the specific input:</p> <p>1– IN 1 2– IN 2 3– IN 3</p> <p>mode – HDCP mode:</p> <p>0 – HDCP Off 3 – HDCP defined according to the connected output (MAC mode)</p>	<p>Set the input HDCP-MODE of IN 1 to Off:</p> <pre>#HDCP-MOD <u>1</u>,0<CR></pre>
HDCP-MOD?	<p>Get HDCP mode.</p> <p>ⓘ Set HDCP working mode on the device input:</p> <p>HDCP supported - HDCP_ON [default].</p> <p>HDCP not supported - HDCP OFF.</p> <p>HDCP support changes following detected sink - MIRROR OUTPUT.</p>	<p>COMMAND</p> <pre>#HDCP-MOD? <u>in_index</u><CR></pre> <p>FEEDBACK</p> <pre>~nn@HDCP-MOD <u>in_index</u>,mode<CR><LF></pre>	<p>in_index – Number that indicates the specific input:</p> <p>1– IN 1 2– IN 2 3– IN 3</p> <p>mode – HDCP mode:</p> <p>0 – HDCP Off 3 – HDCP defined according to the connected output (MAC mode)</p>	<p>Get the input HDCP-MODE of IN 1 HDMI:</p> <pre>#HDCP-MOD? <u>1</u><CR></pre>
HDCP-STAT?	<p>Get HDCP signal status.</p> <p>ⓘ io_mode =1 – get the HDCP signal status of the sink device connected to the specified output.</p> <p>io_mode =0 – get the HDCP signal status of the source device connected to the specified input.</p>	<p>COMMAND</p> <pre>#HDCP-STAT? <u>io_mode</u>,<u>in_index</u><CR></pre> <p>FEEDBACK</p> <pre>~nn@HDCP-STAT <u>io_mode</u>,<u>in_index</u>,status<CR><LF></pre>	<p>io_mode – Input/Output</p> <p>0– Input 1– Output</p> <p>in_index – Number that indicates the specific number of inputs or outputs (based on io_mode):</p> <p>for Input:</p> <p>1– IN 1 2– IN 2 3– IN 3</p> <p>for output:</p> <p>1– HDBT OUT</p> <p>status – Signal encryption status - valid values On/Off</p> <p>0– HDCP Off 1– HDCP On</p>	<p>Get the output HDCP-STATUS of IN 1:</p> <pre>#HDCP-STAT? <u>0</u>,1<CR></pre>
HELP	<p>Get command list or help for specific command.</p>	<p>COMMAND</p> <pre>#HELP<CR></pre> <pre>#HELP <u>cmd_name</u><CR></pre> <p>FEEDBACK</p> <p>1. Multi-line:</p> <pre>~nn@Device <u>cmd_name</u>,<u>cmd_name</u>..<CR><LF></pre> <p>To get help for command use: HELP (COMMAND_NAME)<CR><LF></p> <pre>~nn@HELP <u>cmd_name</u>:<CR><LF></pre> <p>description<CR><LF></p> <p>USAGE:usage<CR><LF></p>	<p>cmd_name – Name of a specific command</p>	<p>Get the command list:</p> <pre>#HELP<CR></pre> <p>To get help for AV-SW-TIMEOUT:</p> <pre>HELP <u>av-sw-timeout</u><CR>></pre>
LOCK-EDID	<p>Lock last read EDID.</p>	<p>COMMAND</p> <pre>#LOCK-EDID <u>in_index</u>,lock_mode<CR></pre> <p>FEEDBACK</p> <pre>~nn@LOCK-EDID <u>in_index</u>,lock_mode<CR><LF></pre>	<p>in_index – Number that indicates the specific input:</p> <p>1– IN 1 2– IN 2 3– IN 3</p> <p>lock_mode – On/Off</p> <p>0– Off unlocks EDID 1– On locks EDID</p>	<p>Lock the last read EDID from the HDMI In 2 input:</p> <pre>#LOCK-EDID <u>2</u>,1<CR></pre>
LOCK-EDID?	<p>Get EDID lock state.</p>	<p>COMMAND</p> <pre>#LOCK-EDID? <u>in_index</u><CR></pre> <p>FEEDBACK</p> <pre>~nn@LOCK-EDID <u>in_index</u>,lock_mode<CR><LF></pre>	<p>in_index – Number that indicates the specific input:</p> <p>1– IN 1 2– IN 2 3– IN 3</p> <p>lock_mode – On/Off</p> <p>0– Off unlocks EDID 1– On locks EDID</p>	<p>Get EDID lock state for Input 2:</p> <pre>#LOCK-EDID? <u>2</u><CR></pre>

Function	Description	Syntax	Parameters/Attributes	Example
LOGIN	<p>Set protocol permission.</p> <p>i The permission system works only if security is enabled with the "SECUR" command.</p> <p>LOGIN allows the user to run commands with an End User or Administrator permission level. When the permission system is enabled, LOGIN enables running commands with the User or Administrator permission level. When set, login must be performed upon each connection.</p> <p>It is not mandatory to enable the permission system in order to use the device.</p> <p>In each device, some connections allow logging in to different levels. Some do not work with security at all.</p> <p>Connection may logout after timeout.</p>	<p>COMMAND</p> <pre>#LOGIN_login_level,password<CR></pre> <p>FEEDBACK</p> <pre>~nn@LOGIN_login_level,password_ok<CR><LF></pre> <p>or</p> <pre>~nn@LOGIN_err_004<CR><LF></pre> <p>(if bad password entered)</p>	<p>login_level – Level of permissions required (User or Admin)</p> <p>password – Predefined password (by PASS command). Default password is an empty string</p>	<p>Set the protocol permission level to Admin (when the password defined in the PASS command is 33333):</p> <pre>#LOGIN_admin,33333<CR></pre>
LOGIN?	<p>Get current protocol permission level.</p> <p>i The permission system works only if security is enabled with the "SECUR" command.</p> <p>For devices that support security, LOGIN allows the user to run commands with an End User or Administrator permission level.</p> <p>In each device, some connections allow logging in to different levels. Some do not work with security at all.</p> <p>Connection may logout after timeout.</p>	<p>COMMAND</p> <pre>#LOGIN?_<CR></pre> <p>FEEDBACK</p> <pre>~nn@LOGIN_login_level<CR><LF></pre>	<p>login_level – Level of permissions required (User or Admin)</p>	<p>Get current protocol permission level:</p> <pre>#LOGIN?<CR></pre>
LOGOUT	<p>Cancel current permission level.</p> <p>i Logs out from End User or Administrator permission levels to Not Secure.</p>	<p>COMMAND</p> <pre>#LOGOUT<CR></pre> <p>FEEDBACK</p> <pre>~nn@LOGOUT_ok<CR><LF></pre>		<pre>#LOGOUT<CR></pre>
MODEL?	<p>Get device model.</p> <p>i This command identifies equipment connected to KIT-401 and notifies of identity changes to the connected equipment. The Matrix saves this data in memory to answer REMOTE-INFO requests.</p>	<p>COMMAND</p> <pre>#MODEL?_<CR></pre> <p>FEEDBACK</p> <pre>~nn@MODEL_model_name<CR><LF></pre>	<p>model_name – String of up to 19 printable ASCII chars</p>	<p>Get the device model:</p> <pre>#MODEL?_<CR></pre>
MUTE	<p>Set audio mute.</p>	<p>COMMAND</p> <pre>#MUTE_out_index,mute_mode<CR></pre> <p>FEEDBACK</p> <pre>~nn@MUTE_out_index,mute_mode<CR><LF></pre>	<p>out_index – Number that indicates the specific output: 1 – AUDIO OUT</p> <p>mute_mode – On/Off 0 – Off 1 – On</p>	<p>Set Output 1 to mute:</p> <pre>#MUTE_1,1<CR></pre>
MUTE?	<p>Get audio mute.</p>	<p>COMMAND</p> <pre>#MUTE?_out_index<CR></pre> <p>FEEDBACK</p> <pre>~nn@MUTE_out_index,mute_mode<CR><LF></pre>	<p>out_index – Number that indicates the specific output: 1 – AUDIO OUT</p> <p>mute_mode – On/Off 0 – Off 1 – On</p>	<p>Get mute status of output 1</p> <pre>#MUTE_1?<CR></pre>

Function	Description	Syntax	Parameters/Attributes	Example
NAME	<p>Set machine (DNS) name.</p> <p>i The machine name is not the same as the model name. The machine name is used to identify a specific machine or a network in use (with DNS feature on).</p>	<p>COMMAND</p> <pre>#NAME _machine_name<CR></pre> <p>FEEDBACK</p> <pre>~nn@NAME _machine_name<CR><LF></pre>	<p>machine_name – String of up to 15 alpha-numeric chars (can include hyphen, not at the beginning or end)</p>	<p>Set the DNS name of the device to room-442:</p> <pre>#NAME _room-442<CR></pre>
NAME?	<p>Get machine (DNS) name.</p> <p>i The machine name is not the same as the model name. The machine name is used to identify a specific machine or a network in use (with DNS feature on).</p>	<p>COMMAND</p> <pre>#NAME? _<CR></pre> <p>FEEDBACK</p> <pre>~nn@NAME _machine_name<CR><LF></pre>	<p>machine_name – String of up to 15 alpha-numeric chars (can include hyphen, not at the beginning or end)</p>	<p>Get the DNS name of the device:</p> <pre>#NAME? _<CR></pre>
NAME-RST	<p>Reset machine (DNS) name to factory default.</p> <p>i Factory default of machine (DNS) name is "KRAMER_" + 4 last digits of device serial number.</p>	<p>COMMAND</p> <pre>#NAME-RST<CR></pre> <p>FEEDBACK</p> <pre>~nn@NAME-RST_ok<CR><LF></pre>		<p>Reset the machine name (S/N last digits are 0102):</p> <pre>#NAME-RST_kramer_0102<CR></pre>
NET-CONFIG	<p>Set a network configuration.</p> <p>i Parameters [DNS1] and [DNS2] are optional.</p> <p>i For Backward compatibility, the id parameter can be omitted. In this case, the Network ID, by default, is 0, which is the Ethernet control port.</p> <p>i If the gateway address is not compliant to the subnet mask used for the host IP, the command will return an error. Subnet and gateway compliancy specified by RFC950.</p>	<p>COMMAND</p> <pre>#NET-CONFIG _netw_id,net_ip,net_mask,gateway,[dns1],[dns2]_<CR></pre> <p>FEEDBACK</p> <pre>~nn@NET-CONFIG _netw_id,net_ip,net_mask,gateway<CR><LF></pre>	<p>netw_id – Network ID—the device network interface (if there are more than one). Counting is 0 based, meaning the control port is '0', additional ports are 1,2,3....</p> <p>net_ip – Network IP</p> <p>net_mask – Network mask</p> <p>gateway – Network gateway</p>	<p>Set the device network parameters to IP address 192.168.113.10, net mask 255.255.0.0, and gateway 192.168.0.1:</p> <pre>#NET-CONFIG_0,192.168.113.10,255.255.0.0,192.168.0.1<CR></pre>
NET-CONFIG?	<p>Get a network configuration.</p>	<p>COMMAND</p> <pre>#NET-CONFIG? _netw_id<CR></pre> <p>FEEDBACK</p> <pre>~nn@NET-CONFIG _netw_id,net_ip,net_mask,gateway<CR><LF></pre>	<p>netw_id – Network ID—the device network interface (if there are more than one). Counting is 0 based, meaning the control port is '0', additional ports are 1,2,3....</p> <p>net_ip – Network IP</p> <p>net_mask – Network mask</p> <p>gateway – Network gateway</p>	<p>Get network configuration:</p> <pre>#NET-CONFIG? _id<CR></pre>
NET-DHCP	<p>Set DHCP mode.</p> <p>i Only 1 is relevant for the mode value. To disable DHCP, the user must configure a static IP address for the device.</p> <p>Connecting Ethernet to devices with DHCP may take more time in some networks.</p> <p>To connect with a randomly assigned IP by DHCP, specify the device DNS name (if available) using the NAME command. You can also get an assigned IP by direct connection to USB or RS-232 protocol port, if available.</p> <p>For proper settings consult your network administrator.</p> <p>i For Backward compatibility, the id parameter can be omitted. In this case, the Network ID, by default, is 0, which is the Ethernet control port.</p>	<p>COMMAND</p> <pre>#NET-DHCP _netw_id,dhcp_state<CR></pre> <p>FEEDBACK</p> <pre>~nn@NET-DHCP _netw_id,dhcp_state<CR><LF></pre>	<p>netw_id – Network ID—the device network interface (if there are more than one). Counting is 0 based, meaning the control port is '0', additional ports are 1,2,3....</p> <p>dhcp_state –</p> <p>1 – Try to use DHCP. (If unavailable, use the IP address set by the factory or the net-ip command).</p>	<p>Enable DHCP mode for port 1, if available:</p> <pre>#NET-DHCP _1,1<CR></pre>

Function	Description	Syntax	Parameters/Attributes	Example
NET-DHCP?	Get DHCP mode. ⓘ For Backward compatibility, the id parameter can be omitted. In this case, the Network ID, by default, is 0, which is the Ethernet control port.	COMMAND #NET-DHCP?_id<CR> FEEDBACK ~nn@NET-DHCP_id,dhcp_mode<CR><LF>	netw_id – Network ID—the device network interface (if there are more than one). Counting is 0 based, meaning the control port is '0', additional ports are 1,2,3... dhcp_mode – 0 – Do not use DHCP. Use the IP set by the factory or using the net-ip or net-config command. 1 – Try to use DHCP. If unavailable, use the IP set by the factory or using the net-ip or net-config command.	Get DHCP mode for port 1: #NET-DHCP?_1<CR>
NET-GATE	Set gateway IP. ⓘ A network gateway connects the device via another network and maybe over the Internet. Be careful of security issues. For proper settings consult your network administrator.	COMMAND #NET-GATE_id,ip_address<CR> FEEDBACK ~nn@NET-GATE_id,ip_address<CR><LF>	ip_address – Format: xxx.xxx.xxx.xxx	Set the gateway IP address to 192.168.0.1: #NET-GATE_id,192.168.000.001<CR>
NET-GATE?	Get gateway IP. ⓘ A network gateway connects the device via another network and maybe over the Internet. Be aware of security problems.	COMMAND #NET-GATE?_id<CR> FEEDBACK ~nn@NET-GATE_id,ip_address<CR><LF>	ip_address – Format: xxx.xxx.xxx.xxx	Get the gateway IP address: #NET-GATE?_id<CR>
NET-IP	Set IP address. ⓘ For proper settings consult your network administrator.	COMMAND #NET-IP_id,ip_address<CR> FEEDBACK ~nn@NET-IP_id,ip_address<CR><LF>	ip_address – Format: xxx.xxx.xxx.xxx	Set the IP address to 192.168.1.39: #NET-IP_id,192.168.001.039<CR>
NET-IP?	Get IP address.	COMMAND #NET-IP?_id<CR> FEEDBACK ~nn@NET-IP_id,ip_address<CR><LF>	ip_address – Format: xxx.xxx.xxx.xxx	Get the IP address: #NET-IP?_id<CR>
NET-MAC?	Get MAC address. ⓘ For backward compatibility, the id parameter can be omitted. In this case, the Network ID, by default, is 0, which is the Ethernet control port.	COMMAND #NET-MAC?_id<CR> FEEDBACK ~nn@NET-MAC_id,mac_address<CR><LF>	id – Network ID—the device network interface (if there are more than one). Counting is 0 based, meaning the control port is '0', additional ports are 1,2,3... mac_address – Unique MAC address. Format: XX-XX-XX-XX-XX-XX where X is hex digit	#NET-MAC?_id<CR>
NET-MASK	Set subnet mask. ⓘ For proper settings consult your network administrator.	COMMAND #NET-MASK_id,net_mask<CR> FEEDBACK ~nn@NET-MASK_id,net_mask<CR><LF>	net_mask – Format: xxx.xxx.xxx.xxx	Set the subnet mask to 255.255.0.0: #NET-MASK_id,255.255.000.000<CR>
NET-MASK?	Get subnet mask.	COMMAND #NET-MASK?_id<CR> FEEDBACK ~nn@NET-MASK_id,net_mask<CR><LF>	net_mask – Format: xxx.xxx.xxx.xxx	Get the subnet mask: #NET-MASK?_id<CR>
PASS	Set password for login level. ⓘ The default password is an empty string.	COMMAND #PASS_login_level,password<CR> FEEDBACK ~nn@PASS_login_level,password<CR><LF>	login_level – Level of login to set (End User or Administrator). password – Password for the login_level . Up to 15 printable ASCII chars	Set the password for the Admin protocol permission level to 33333: #PASS_admin,33333<CR>
PASS?	Get password for login level. ⓘ The default password is an empty string.	COMMAND #PASS?_login_level<CR> FEEDBACK ~nn@PASS_login_level,password<CR><LF>	login_level – Level of login to set (End User or Administrator). password – Password for the login_level . Up to 15 printable ASCII chars	Get the password for the Admin protocol permission level: #PASS?_admin<CR>
PRIORITY?	Get input priority.	COMMAND #PRIORITY?_layer<CR> FEEDBACK ~nn@PRIORITY_layer,PRIORITY1,PRIORITY2<CR><LF>	layer – Layer enumeration: 1 – Video 2 – Audio PRIORITY1 – priority for input 1 PRIORITY2 – priority for input 2	Get video input priority: #PASS?_1<CR>
PROG-BTN-MOD	Set programmable button mode.	COMMAND #PROG-BTN-MOD_id,mode<CR> FEEDBACK ~nn@PROG-BTN-MOD_id,mode<CR><LF>	mode – On/Off 0 – Default behavior 1 – Programmable	Set programmable button to default behavior: #PROG-BTN-MOD_id,0<CR>
PROG-BTN-MOD?	Get programmable button mode.	COMMAND #PROG-BTN-MOD?_id<CR> FEEDBACK ~nn@PROG-BTN-MOD_id,mode<CR><LF>	mode – On/Off 0 – Default behavior 1 – Programmable	Get programmable button state: #PROG-BTN-MOD_id?<CR>
PROT-VER?	Get device protocol version.	COMMAND #PROT-VER?_id<CR> FEEDBACK ~nn@PROT-VER_id,3000:version<CR><LF>	version – XX.XX where X is a decimal digit	Get the device protocol version: #PROT-VER?_id<CR>

Function	Description	Syntax	Parameters/Attributes	Example
RESET	Reset device. ⓘ To avoid locking the port due to a USB bug in Windows, disconnect USB connections immediately after running this command. If the port was locked, disconnect and reconnect the cable to reopen the port.	COMMAND #RESET<CR> FEEDBACK ~nn@RESET_ ok<CR><LF>		Reset the device: #RESET<CR>
ROUTE	Set layer routing. ⓘ This command replaces all other routing commands.	COMMAND #ROUTE_ layer_type, out_index, in_index<CR> FEEDBACK ~nn@ROUTE_ layer_type, out_index<CR><LF>	layer_type Layer Enumeration 1- Video 3- Data out_index for video layer: 1- HDBT OUT for video layer: 1- HDBT OUT 2- KIT-401 data port 3- KIT-401 internal control port in_index - Source id for video layer: 1- IN 1 2- IN 2 3- IN 3 for video layer: 1- HDBT OUT 2- KIT-401 data port 3- KIT-401 internal control port	Route video IN 2 to video HDBT OUT: #ROUTE_ 1, 1, 2<CR>
ROUTE?	Get layer routing. ⓘ This command replaces all other routing commands.	COMMAND #ROUTE?_ layer_type, out_index<CR> FEEDBACK ~nn@ROUTE_ layer_type, out_index, in_index<CR><LF>	layer_type Layer Enumeration 1- Video 3- Data out_index for video layer: 1- HDBT OUT for data layer: 1- HDBT OUT 2- KIT-401 data port 3- KIT-401 internal control port in_index - Source id for video layer: 1- IN 1 2- IN 2 3- IN 3 for video layer: 1- HDBT OUT 2- KIT-401 data port 3- KIT-401 internal control port	Get the layer routing: #ROUTE?_ 1, 1<CR>
SECUR	Start/stop security. ⓘ The permission system works only if security is enabled with the "SECUR" command.	COMMAND #SECUR_ security_state<CR> FEEDBACK ~nn@SECUR_ security_state<CR><LF>	security_state - Security state 0- OFF (disables security) 1- ON (enables security)	Enable the permission system: #SECUR_ 0<CR>
SECUR?	Get current security state. ⓘ The permission system works only if security is enabled with the "SECUR" command.	COMMAND #SECUR?_<CR> FEEDBACK ~nn@SECUR_ security_state<CR><LF>	security_state - Security state 0- OFF (disables security) 1- ON (enables security)	Get current security state: #SECUR?_<CR>
SIGNAL?	Get input signal status.	COMMAND #SIGNAL?_ in_index<CR> FEEDBACK ~nn@SIGNAL_ in_index, status<CR><LF>	in_index - Number that indicates the specific input: 1- IN 1 2- IN 2 3- IN 3 status - Signal status according to signal validation: 0- Off 1- On	Get the input signal lock status of IN 1: #SIGNAL?_ 1<CR>
SN?	Get device serial number.	COMMAND #SN?_<CR> FEEDBACK ~nn@SN_ serial_num<CR><LF>	serial_num - 14 decimal digits, factory assigned	Get the device serial number: #SN?_<CR>
TIME	Set device time and date. ⓘ The year must be 4 digits. The device does not validate the day of week from the date. Time format - 24 hours. Date format - Day, Month, Year.	COMMAND #TIME_ day_of_week, date, data<CR> FEEDBACK ~nn@TIME_ day_of_week, date, data<CR><LF>	day_of_week - One of {SUN, MON, TUE, WED, THU, FRI, SAT} date - Format: DD-MM-YYYY. data - Format: hh:mm:ss where hh = hours mm = minutes ss = seconds	Set device time and date to December 5, 2018 at 2:30pm: #TIME_ mon_ 05-12-2018, 14: 30: 00<CR>

Function	Description	Syntax	Parameters/Attributes	Example
TIME?	Get device time and date. ⓘ The year must be 4 digits. The device does not validate the day of week from the date. Time format - 24 hours. Date format - Day, Month, Year.	COMMAND #TIME?_<CR> FEEDBACK ~nn@TIME_<day_of_week,date,data><CR><LF>	day_of_week – One of {SUN,MON,TUE,WED,THU,FRI,SAT} date – Format: YYYY/MM/DD where YYYY = Year MM = Month DD = Day data – Format: hh:mm:ss where hh = hours mm = minutes ss = seconds	Get device time and date: #TIME?<CR>
TIME-LOC	Set local time offset from UTC/GMT. ⓘ If the time server is configured, device time calculates by adding UTC_off to UTC time (that it got from the time server) + 1 hour if daylight savings time is in effect. TIME command sets the device time without considering these settings.	COMMAND #TIME-LOC_<utc_off,dst_state><CR> FEEDBACK ~nn@TIME-LOC_<utc_off,dst_state><CR><LF>	utc_off – Offset of device time from UTC/GMT (without daylight time correction) dst_state – Daylight saving time state 0 – no daylight saving time 1 – daylight saving time	Set local time offset to 3 with no daylight-saving time: #TIME-LOC_3,0<CR>
TIME-LOC?	Get local time offset from UTC/GMT. ⓘ If the time server is configured, device time calculates by adding UTC_off to UTC time (that it got from the time server) + 1 hour if daylight savings time is in effect. TIME command sets the device time without considering these settings.	COMMAND #TIME-LOC?_<CR> FEEDBACK ~nn@TIME-LOC_<utc_off,dst_state><CR><LF>	utc_off – Offset of device time from UTC/GMT (without daylight time correction) dst_state – Daylight saving time state 0 – no daylight saving time 1 – daylight saving time	Get local time offset from UTC/GMT: #TIME-LOC?<CR>
TIME-SRV	Set time server. ⓘ This command is needed for setting UDP timeout for the current client list.	COMMAND #TIME-SRV_<mode,time_server_ip, sync_hour><CR> FEEDBACK ~nn@TIME-SRV_<mode,time_server_ip, sync_hour, server_status><CR><LF>	mode – On/Off 0 – Off 1 – On time_server_ip – Time server IP address sync_hour – Hour in day for time server sync server_status – On/Off	Set time server with IP address of 128.138.140.44 to ON: #TIME-SRV_1,128.138.140.44,0,1<CR>
TIME-SRV?	Get time server. ⓘ This command is needed for setting UDP timeout for the current client list.	COMMAND #TIME-SRV?_<CR> FEEDBACK ~nn@TIME-SRV_<mode,time_server_ip, sync_hour, server_status><CR><LF>	mode – On/Off 0 – Off 1 – On time_server_ip – Time server IP address sync_hour – Hour in day for time server sync server_status – On/Off	Get time server: #TIME-SRV?<CR>
TUNNEL-CTRL	Send an asynchronous command to a remote device.	COMMAND #TUNNEL-CTRL_<stage,stage_id, "command"><CR> FEEDBACK ~nn@TUNNEL-CTRL_<stage,stage_id, "command"><CR><LF>	stage – 1 stage_id – 1 "command" – command to send to the receiver	Set the receiver relay state to open from the transmitter: #TUNNEL-CTRL_1,1,"RELAY-STATE_1,0"<CR> Send a command from the transmitter to the receiver's RS-232 port (using the receiver command TUNNEL-232): #TUNNEL-CTRL_1,1,"TUNNEL-232_<cmd arg, arg' 9600"><CR>
VERSION?	Get firmware version number.	COMMAND #VERSION?_<CR> FEEDBACK ~nn@VERSION_<firmware_version><CR><LF>	firmware_version – XX.XX.XXXX where the digit groups are: major.minor.build version	Get the device firmware version number: #VERSION?_<CR>
VGA-PHASE	Set ADC (VGA) sampling phase. ⓘ Response answers with absolute value after decreasing or increasing value.	COMMAND #VGA-PHASE_<in_id,value><CR> FEEDBACK ~nn@VGA-PHASE_<in_id,value><CR><LF>	in_id – Indicates the ID of the input: 3 – IN 3 value – Phase parameter in LSB units (1 to 30) ++ increase current value – decrease current value	Increase the current value of the ADC (VGA) sampling phase: #VGA-PHASE_3,++<CR>
VGA-PHASE?	Get ADC (VGA) sampling phase. ⓘ Response answers with absolute value after decreasing or increasing value.	COMMAND #VGA-PHASE?_<in_id><CR> FEEDBACK ~nn@VGA-PHASE_<in_id,value><CR><LF>	in_id – Indicates the ID of the input: 3 – IN 3 value – Phase parameter in LSB units (1 to 30) ++ increase current value – decrease current value	Get ADC (VGA) sampling phase: #VGA-PHASE?_3<CR>

Function	Description	Syntax	Parameters/Attributes	Example
VMUTE	Set enable/disable video on output. ① Video mute parameter 2 (blank picture) is not supported.	COMMAND #VMUTE _u out_index,flag<CR> FEEDBACK ~nn@VMUTE _u out_index,flag<CR><LF>	out_index – Number that indicates the specific output: 1-N (N= the total number of outputs) flag – Video Mute 0– Video disabled 1– Video enabled 2– Blank picture	Disable the video output on OUT 2: #VMUTE _u 2,0<CR>
VMUTE?	Get video on output status. ① Video mute parameter 2 (blank picture) is not supported.	COMMAND #VMUTE? _u out_index<CR> FEEDBACK ~nn@VMUTE _u out_index,flag<CR><LF>	out_index – Number that indicates the specific output: 1– HDBT OUT flag – Video Mute 0– Video disabled 1– Video enabled 2– Blank picture	Get video on output status: #VMUTE? _u 2<CR>

KIT-400R Protocol Commands

Function	Description	Syntax	Parameters/Attributes	Example
#	Protocol handshaking. ① Validates the Protocol 3000 connection and gets the machine number. Step-in master products use this command to identify the availability of a device.	COMMAND #<CR> FEEDBACK ~nn@ok<CR><LF>		#<CR>
AUD-LVL	Set volume level.	COMMAND #AUD-LVL _u io_mode,io_index,vol_level<CR> FEEDBACK ~nn@AUD-LVL _u io_mode,io_index,vol_level<CR><LF>	io_mode – Input/Output 1– Output io_index – Number that indicates the specific input or output port: 1 vol_level – Volume level 0 to 100 ++ (increase current value by 1dB); -- (decrease current value by 1dB)	Set audio level to 50: #AUD-LVL _u 1,1,50<CR>
AUD-LVL?	Get volume level.	COMMAND #AUD-LVL? _u io_mode,io_index<CR> FEEDBACK ~nn@AUD-LVL _u io_mode,io_index,vol_level<CR><LF>	io_mode – Input/Output 1– Output io_index – Number that indicates the specific input or output port: 1 vol_level – Volume level 0 to 100	Get audio output level #AUD-LVL? _u 1,1<CR>
AV-SW-MODE	Set input auto switch mode (per output).	COMMAND #AV-SW-MODE _u layer_type,out_index,connection_mode<CR> FEEDBACK ~nn@AV-SW-MODE _u layer_type,out_index,connection_mode<CR><LF>	layer_type – Number that indicates the signal type: 1– Video out_index – Number that indicates the specific output: 1 connection_mode – Connection mode 0– manual 2– last connected switch	Set input auto switch mode (per output) to Manual: #AV-SW-MODE _u 1,1,0<CR>
AV-SW-MODE?	Get input auto switch mode (per output).	COMMAND #AV-SW-MODE? _u layer_type,out_index<CR> FEEDBACK ~nn@AV-SW-MODE _u layer_type,out_index,connection_mode<CR><LF>	layer_type – Number that indicates the signal type: 1– Video out_index – Number that indicates the specific output: 1 connection_mode – Connection mode 0– manual 2– last connected switch	Get the input audio switch mode: #AV-SW-MODE? _u 1,1<CR>
BUILD-DATE?	Get device build date.	COMMAND #BUILD-DATE? _u <CR> FEEDBACK ~nn@BUILD-DATE _u date,time<CR><LF>	date – Format: YYYY/MM/DD where YYYY = Year MM = Month DD = Day time – Format: hh:mm:ss where hh = hours mm = minutes ss = seconds	Get the device build date: #BUILD-DATE? _u <CR>
CEC	Set display to ON/OFF	COMMAND #CEC _u state<CR> FEEDBACK ~nn@CEC _u state<CR><LF>	state – CEC state 0 – Off 1 – On	Set display to OFF via CEC: #CEC-ON<CR>
CEC-PASS	Set CEC device bypass.	COMMAND #CEC-PASS _u state<CR> FEEDBACK ~nn@CEC-PASS _u state<CR><LF>	state – CEC state 0 – Off 1 – On	Set bypass device state: #CEC-PASS _u 1<CR>
CEC-PASS?	Get CEC device bypass state.	COMMAND #CEC-PASS? _u <CR> FEEDBACK ~nn@CEC-PASS _u state<CR><LF>	state – CEC state 0 – Off 1 – On	Get bypass device state: #CEC-PASS? _u <CR>

Function	Description	Syntax	Parameters/Attributes	Example
CPEDID	<p>Copy EDID data from the output to the input EEPROM.</p> <p>i Destination bitmap size depends on device properties (for 64 inputs it is a 64-bit word).</p> <p>Example: bitmap 0x0013 means inputs 1,2 and 5 are loaded with the new EDID.</p> <p>In certain products Safe_mode is an optional parameter. See the HELP command for its availability.</p>	<p>COMMAND</p> <pre>#CPEDID_ edid_io,src_id,edid_io,dest_bitmap<CR></pre> <p>or</p> <pre>#CPEDID_ edid_io,src_id,edid_io,dest_bitmap, safe_mode<CR></pre> <p>FEEDBACK</p> <pre>~nn@CPEDID_ edid_io,src_id,edid_io,dest_bitmap<CR><LF></pre> <pre>~nn@CPEDID_ edid_io,src_id,edid_io,dest_bitmap,safe_mode<CR><LF></pre>	<p>edid_io – EDID source type (usually output)</p> <p>1 – Output</p> <p>src_id – Number of chosen source stage</p> <p>For HDBT:</p> <p>1 – Def. 1080P</p> <p>2 – Def. 4K2K(3G)</p> <p>3 – Def. 4K2K(3G-4:2:0)</p> <p>4 – User1</p> <p>5 – User2</p> <p>6 – Output</p> <p>For HDMI:</p> <p>1 – Def. 1080P</p> <p>2 – Def. 4K2K(3G)</p> <p>3 – Def. 4K2K(3G-4:2:0)</p> <p>4 – Def. 4K2K(6G)</p> <p>5 – User1</p> <p>6 – User2</p> <p>7 – Output</p> <p>edid_io – EDID destination type (usually input)</p> <p>0 – Input</p> <p>dest_bitmap – Bitmap representing destination IDs. Format: XXXX...X, where X is hex digit. The binary form of every hex digit represents corresponding destinations.</p> <p>0x01 – for HDBT.</p> <p>0x02 – for HDMI</p> <p>safe_mode – Safe mode</p> <p>0 – device accepts the EDID as is without trying to adjust</p> <p>1 – device tries to adjust the EDID (default value if no parameter is sent)</p>	<p>Copy the EDID data from the Output 1 (EDID source) to the Input:</p> <pre>#CPEDID_ 1,1,0,0x1<CR></pre> <p>Copy the EDID data from the default EDID source to the Input:</p> <pre>#CPEDID_ 2,0,0,0x1<CR></pre>
DISPLAY?	Get output HPD status.	<p>COMMAND</p> <pre>#DISPLAY?_ out_index<CR></pre> <p>FEEDBACK</p> <pre>~nn@DISPLAY_ out_index,status<CR><LF></pre>	<p>out_index – Number that indicates the specific output: 1</p> <p>status – HPD status according to signal validation</p> <p>0 – Signal or sink is not valid</p> <p>1 – Signal or sink is valid</p>	Get the output HPD status of Output 1:
HDCP-MOD	<p>Set HDCP mode.</p> <p>i Set HDCP working mode on the device input:</p> <p>HDCP supported - HDCP_ON [default].</p> <p>HDCP not supported - HDCP OFF.</p> <p>HDCP support changes following detected sink - MIRROR OUTPUT.</p> <p>When you define 3 as the mode, the HDCP status is defined according to the connected output in the following priority: OUT 1, OUT 2. If the connected display on OUT 2 supports HDCP, but OUT 1 does not, then HDCP is defined as not supported. If OUT 1 is not connected, then HDCP is defined by OUT 2.</p>	<p>COMMAND</p> <pre>#HDCP-MOD_ stage,stage_id,mode<CR></pre> <p>FEEDBACK</p> <pre>~nn@HDCP-MOD_ stage,stage_id,mode<CR><LF></pre>	<p>stage – Input/Output</p> <p>0 – Input</p> <p>1 – Output</p> <p>stage_id – Input number:</p> <p>1 – HDBT IN</p> <p>2 – HDMI IN</p> <p>Output number</p> <p>1 – HDMI OUT</p> <p>mode – HDCP mode</p> <p>Input:</p> <p>0 – Off</p> <p>1 – On</p> <p>Output:</p> <p>2 – Follow input</p> <p>3 – Follow output</p>	Set the HDBT input HDCP-MODE of HDBT input to Off:
HDCP-MOD?	<p>Get HDCP mode.</p> <p>i Set HDCP working mode on the device input:</p> <p>HDCP supported - HDCP_ON [default].</p> <p>HDCP not supported - HDCP OFF.</p> <p>HDCP support changes following detected sink - MIRROR OUTPUT.</p>	<p>COMMAND</p> <pre>#HDCP-MOD?_ stage,stage_id<CR></pre> <p>FEEDBACK</p> <pre>~nn@HDCP-MOD_ stage,stage_id,mode<CR><LF></pre>	<p>stage – Input/Output</p> <p>0 – Input</p> <p>1 – Output</p> <p>stage_id – Input number:</p> <p>1 – HDBT IN</p> <p>2 – HDMI IN</p> <p>Output number</p> <p>1 – HDMI OUT</p> <p>mode – HDCP mode</p> <p>Input:</p> <p>0 – Off</p> <p>1 – On</p> <p>Output:</p> <p>2 – Follow input</p> <p>3 – Follow output</p>	Get the input HDCP-MODE of HDMI input:

Function	Description	Syntax	Parameters/Attributes	Example
HELP	Get command list or help for specific command.	COMMAND #HELP<CR> #HELP_<cmd_name><CR> FEEDBACK 1. Multi-line: ~nn@Device_<cmd_name>,<cmd_name>.<CR><LF> To get help for command use: HELP (COMMAND_NAME)<CR><LF> ~nn@HELP_<cmd_name>:<CR><LF> description<CR><LF> USAGE:usage<CR><LF>	cmd_name – Name of a specific command	Get the command list: #HELP<CR> To get help for AV-SW-TIMEOUT: HELP_<av-sw-timeout><CR><LF>
IMAGE-PROP	Set the image size.	COMMAND #IMAGE-PROP_<scaler_index>,<prop><CR> FEEDBACK ~nn@IMAGE-PROP_<scaler_index>,<prop><CR><LF>	scaler_index – Scaler number: 1 prop – 0– Overscan 1– Full 2– Best fit 3– Panscan 4– Letterbox 5– Underscan 2 6– Underscan 1 7– Follow in	Set the image size to Letterbox: #IMAGE-PROP_1,4<CR>
IMAGE-PROP?	Get the image size.	COMMAND #IMAGE-PROP?_<scaler_index><CR> FEEDBACK ~nn@IMAGE-PROP_<scaler_index>,<prop><CR><LF>	scaler_index – Scaler number: 1 prop – 0– Overscan 1– Full 2– Best fit 3– Panscan 4– Letterbox 5– Underscan 2 6– Underscan 1 7– Follow in	Get mute status of the output #IMAGE-PROP?_1<CR>
LOCK-FP	Lock the front panel.	COMMAND #LOCK-FP_<lock/unlock><CR> FEEDBACK ~nn@LOCK-FP_<lock/unlock><CR><LF>	lock/unlock – 0– Unlock 1– Lock	Lock front panel buttons: #LOCK-FP_1<CR>
LOCK-FP?	Get the front panel lock state.	COMMAND #LOCK-FP?_<lock/unlock><CR> FEEDBACK ~nn@LOCK-FP_<lock/unlock><CR><LF>	lock/unlock – 0– Unlocked 1– Locked	Get front panel lock state #LOCK-FP?_1<CR>
MODEL?	Get device model. ⓘ This command identifies equipment connected to KIT-401 and notifies of identity changes to the connected equipment. The Matrix saves this data in memory to answer REMOTE-INFO requests.	COMMAND #MODEL?_<model_name><CR> FEEDBACK ~nn@MODEL_<model_name><CR><LF>	model_name – String of up to 19 printable ASCII chars	Get the device model: #MODEL?_<model_name><CR>
MUTE	Set audio mute.	COMMAND #MUTE_<out_index>,<mute_mode><CR> FEEDBACK ~nn@MUTE_<out_index>,<mute_mode><CR><LF>	out_index – Number that indicates the specific output: 1 mute_mode – On/Off 0– Off 1– On	Set the output to mute: #MUTE_1,1<CR>
MUTE?	Get audio mute.	COMMAND #MUTE?_<out_index><CR> FEEDBACK ~nn@MUTE_<out_index>,<mute_mode><CR><LF>	out_index – Number that indicates the specific output: 1 mute_mode – On/Off 0– Off 1– On	Get mute status of the output #MUTE?_1<CR>
PROT-VER?	Get device protocol version.	COMMAND #PROT-VER?_<version><CR> FEEDBACK ~nn@PROT-VER_3000:<version><CR><LF>	version – XX.XX where X is a decimal digit	Get the device protocol version: #PROT-VER?_<version><CR>
RELAY-STATE	Set relay state.	COMMAND #RELAY-STATE_<relay_id>,<state><CR> FEEDBACK ~nn@RELAY-STATE_<relay_id>,<state><CR><LF>	relay_id – Relay number: 1 state – Relay state 0– (open) 1– (close)	Set relay 1 to closed: #RELAY-STATE_1,1<CR>
RELAY-STATE?	Get relay state.	COMMAND #RELAY-STATE?_<relay_id><CR> FEEDBACK ~nn@RELAY-STATE_<relay_id>,<state><CR><LF>	relay_id – Relay number: 1 relay_state – Relay state 0– (open) 1– (close)	Get relay state: #RELAY-STATE?_1<CR>
RESET	Reset device. ⓘ To avoid locking the port due to a USB bug in Windows, disconnect USB connections immediately after running this command. If the port was locked, disconnect and reconnect the cable to reopen the port.	COMMAND #RESET<CR> FEEDBACK ~nn@RESET_<ok><CR><LF>		Reset the device: #RESET<CR>

Function	Description	Syntax	Parameters/Attributes	Example
ROUTE	Set layer routing. ⓘ This command replaces all other routing commands.	COMMAND #ROUTE_ layer_type, out_index, in_index<CR> FEEDBACK ~nn@ROUTE_ layer_type, out_index<CR><LF>	layer_type Layer Enumeration 1- Video out_index 1,* - Output in_index - Source id 1-HDBT Input 2-HDMI Input	Route HDBT to the output: #ROUTE_1,1,1<CR>
ROUTE?	Get layer routing. ⓘ This command replaces all other routing commands.	COMMAND #ROUTE?_ layer_type, out_index<CR> FEEDBACK ~nn@ROUTE_ layer_type, out_index, in_index<CR><LF>	layer_type Layer Enumeration 1- Video out_index 1,* - Output in_index - Source id 1-HDBT Input 2-HDMI Input	Get the layer routing: #ROUTE?_1,*<CR>
SCLR-AS	Set auto-sync features. ⓘ Sets the auto sync features for the selected scaler.	COMMAND #SCLR-AS_ scaler_index, sync_speed<CR> FEEDBACK ~nn@SCLR-AS_ scaler_index, sync_speed<CR><LF>	scaler_index - Scaler Number: 1 - Scaler sync_speed - 0, 1 or 2 0- off 1- fast 2- slow	Set auto-sync features: #SCLR-AS_1,1<CR>
SCLR-AS?	Get auto-sync features. ⓘ Gets the auto sync features for the selected scaler.	COMMAND #SCLR-AS?_ scaler_index<CR> FEEDBACK ~nn@SCLR-AS_ scaler_index, sync_speed<CR><LF>	scaler_index - Scaler Number: 1 - Scaler sync_speed - 0, 1 or 2 0- off 1- fast 2- slow	Get auto-sync features: #SCLR-AS?_1<CR>
SCLR-AUDIO-DELAY	Set the scaler audio delay. ⓘ Sets the audio delay for the selected audio output.	COMMAND #SCLR-AUDIO-DELAY_ scaler_index, delay<CR> FEEDBACK ~nn@SCLR-AUDIO-DELAY_ scaler_index, delay<CR><LF>	scaler_index - Audio output number 1- Scaler delay - 0- Off 1- 40ms 2- 110ms 3- 150ms	Set the scaler audio delay to 40ms: #SCLR-AUDIO-DELAY_1,1<CR>
SCLR-AUDIO-DELAY?	Get the scaler audio delay. ⓘ Gets the audio delay for the selected audio output.	COMMAND #SCLR-AUDIO-DELAY?_ scaler_index<CR> FEEDBACK ~nn@SCLR-AUDIO-DELAY_ scaler_index, delay<CR><LF>	scaler_index - Audio output number 1- Scaler delay - 0- Off 1- 40ms 2- 110ms 3- 150ms	Get the scaler audio delay: #SCLR-AUDIO-DELAY?_1<CR>
SIGNAL?	Get input signal status.	COMMAND #SIGNAL?_ in_index<CR> FEEDBACK ~nn@SIGNAL_ in_index, status<CR><LF>	in_index - Number that indicates the specific input: 1-HDBT Input 2-HDMI Input status - Signal status according to signal validation: 0- Off (signal or sink is not valid) 1- On (signal or sink is valid)	Get the input signal lock status of IN 1: #SIGNAL?_1<CR>
SN?	Get device serial number.	COMMAND #SN?_<CR> FEEDBACK ~nn@SN_ serial_num<CR><LF>	serial_num - 14 decimal digits, factory assigned	Get the device serial number: #SN?_<CR>
TUNNEL-232	Send a command to output on the receiver's RS-232 port.	COMMAND #TUNNEL-232_ 'payload' baud<CR> FEEDBACK ~nn@TUNNEL-232_ 'payload' baud<CR><LF>	payload - the data that will be output on the receiver's RS-232 port. baud - 9600, 19200, 38400, 57600, 115200	Send a command to the transmitter instructing the receiver to output the data "disp_off" on its RS-232 port at 9600 baud: #TUNNEL-CTRL_1,1,"TUNNEL-232_ 'disp_off'9600"<CR>
VERSION?	Get firmware version number.	COMMAND #VERSION?_<CR> FEEDBACK ~nn@VERSION_ firmware_version<CR><LF>	firmware version - XX.XX.XXXX where the digit groups are: major.minor.build version	Get the device firmware version number: #VERSION?_<CR>
VFRZ	Set freeze on selected output.	COMMAND #VFRZ_ out_index, freeze_flag<CR> FEEDBACK ~nn@VFRZ_ out_index, freeze_flag<CR><LF>	out_index - Number that indicates the specific output: 1 freeze_flag - 0- Off 1- On 2- Freeze Only 3- Freeze and Mute 4- Mute Only	Set freeze on the output: #VFRZ_1,1<CR>
VFRZ?	Get output freeze status.	COMMAND #VFRZ?_ out_index<CR> FEEDBACK ~nn@VFRZ_ out_index, freeze_flag<CR><LF>	out_index - Number that indicates the specific output: 1 freeze_flag - 0- Off 1- On 2- Freeze Only 3- Freeze and Mute 4- Mute Only	Get output freeze status: #VFRZ?_1<CR>

Function	Description	Syntax	Parameters/Attributes	Example
VID-RES	<p>Set output resolution.</p> <p>ⓘ "Set" command with is_native=ON sets native resolution on selected output (resolution index sent = 0). Device sends as answer actual VIC ID of native resolution.</p> <p>To use "custom resolutions" (entries 100-105 In View Modes), define them using the DEF-RES command.</p>	<p>COMMAND</p> <pre>#VID-RES_{io_mode,io_index,is_native,resolution}<CR></pre> <p>FEEDBACK</p> <pre>~nn@VID-RES_{io_mode,io_index,is_native,resolution}<CR><LF></pre>	<p>io_mode – Input/Output</p> <p>1– Output</p> <p>io_index –1</p> <p>is_native – Native resolution flag</p> <p>1– On</p> <p>resolution – Resolution index:</p> <p>0– NATIVE</p> <p>1– 640x480 60</p> <p>2– 800x600 60</p> <p>3– 1024x768 60</p> <p>4– 1280x768 60</p> <p>5– 1280x800 60</p> <p>6– 1280x1024 60</p> <p>7– 1360x768 60</p> <p>8– 1400x1050 60</p> <p>9– 1440x900 60</p> <p>10 – 1600x1200 60</p> <p>11 – 1680x1050 60</p> <p>12 – 1920x1200 60 RB</p> <p>13 – 2560x1600 60 RB</p> <p>14 – 1920x1080 60</p> <p>15 – 1280x720 60</p> <p>16 – 2048x1080 50</p> <p>17 – 2048x1080 60</p> <p>18 – 2560x1440 60 RB</p> <p>19 – 3440x1440 30</p> <p>20 – 3440x1440 60</p> <p>21 – 720x480P 60</p> <p>22 – 720x576P 50</p> <p>23 – 1280x720P 50</p> <p>24 – 1280x720P 60</p> <p>25 – 1920x1080P 24</p> <p>26 – 1920x1080P 25</p> <p>27 – 1920x1080P 30</p> <p>28 – 1920x1080P 50</p> <p>29 – 1920x1080P 60</p> <p>30 – 2560x1080P 50</p> <p>31 – 2560x1080P 60</p> <p>32 – 3840x2160P 24</p> <p>33 – 3840x2160P 25</p> <p>34 – 3840x2160P 30</p> <p>35 – 3840x2160P 50</p> <p>36 – 3840x2160P 60</p>	<p>Set output resolution:</p> <pre>#VID-RES_{1,1,1,1}<CR></pre>
VID-RES?	<p>Get output resolution.</p> <p>ⓘ "Get" command with is_native=ON returns native resolution VIC, with is_native=OFF returns current resolution.</p> <p>To use "custom resolutions" (entries 100-105 In View Modes), define them using the DEF-RES command.</p>	<p>COMMAND</p> <pre>#VID-RES?_{io_mode,io_index,is_native}<CR></pre> <p>FEEDBACK</p> <pre>~nn@VID-RES?_{io_mode,io_index,is_native,resolution}<CR><LF></pre>	<p>io_mode – Input/Output</p> <p>0– Input</p> <p>1– Output</p> <p>io_index – Number that indicates the specific input or output port:</p> <p>1-N (N= the total number of input or output ports)</p> <p>is_native – Native resolution flag</p> <p>1– On</p> <p>resolution – Resolution index:</p> <p>0– NATIVE</p> <p>1– 640x480 60</p> <p>2– 800x600 60</p> <p>3– 1024x768 60</p> <p>4– 1280x768 60</p> <p>5– 1280x800 60</p> <p>6– 1280x1024 60</p> <p>7– 1360x768 60</p> <p>8– 1400x1050 60</p> <p>9– 1440x900 60</p> <p>10 – 1600x1200 60</p> <p>11 – 1680x1050 60</p> <p>12 – 1920x1200 60 RB</p> <p>13 – 2560x1600 60 RB</p> <p>14 – 1920x1080 60</p> <p>15 – 1280x720 60</p> <p>16 – 2048x1080 50</p> <p>17 – 2048x1080 60</p> <p>18 – 2560x1440 60 RB</p> <p>19 – 3440x1440 30</p> <p>20 – 3440x1440 60</p> <p>21 – 720x480P 60</p> <p>22 – 720x576P 50</p> <p>23 – 1280x720P 50</p> <p>24 – 1280x720P 60</p> <p>25 – 1920x1080P 24</p> <p>26 – 1920x1080P 25</p> <p>27 – 1920x1080P 30</p> <p>28 – 1920x1080P 50</p> <p>29 – 1920x1080P 60</p> <p>30 – 2560x1080P 50</p> <p>31 – 2560x1080P 60</p> <p>32 – 3840x2160P 24</p> <p>33 – 3840x2160P 25</p> <p>34 – 3840x2160P 30</p> <p>35 – 3840x2160P 50</p> <p>36 – 3840x2160P 60</p>	<p>Set output resolution:</p> <pre>#VID-RES?_{1,1,1,1}<CR></pre>

Function	Description	Syntax	Parameters/Attributes	Example
VMUTE	Set enable/disable video on output. ⓘ Video mute parameter 2 (blank picture) is not supported.	COMMAND #VMUTE_<out_index>,flag<CR> FEEDBACK ~nn@VMUTE_<out_index>,flag<CR><LF>	out_index – Number that indicates the specific output: 1 flag – Video Mute 0– Video disabled+5V low 1– Video enabled +5V high 2– Blank picture + 5V high	Disable the video output: #VMUTE_1,0<CR>
VMUTE?	Get video on output status. ⓘ Video mute parameter 2 (blank picture) is not supported.	COMMAND #VMUTE?_<out_index><CR> FEEDBACK ~nn@VMUTE_<out_index>,flag<CR><LF>	out_index – Number that indicates the specific output: 1 flag – Video Mute 0– Video enabled 1– Video disabled 2– Blank picture	Get video on output status: #VMUTE?_1<CR>
X-AUD-LVL	Set audio level of a specific signal. ⓘ This is an Extended Protocol 3000 command.	COMMAND #X-AUD-LVL_<direction_type>. <port_format>. <port_index>. <signal_type>. <index>,audio_level<CR> FEEDBACK ~nn@X-AUD-LVL_<direction_type>. <port_format>. <port_index>. <signal_type>. <index>,audio_level<CR><LF>	The following attributes comprise the signal ID: ▪ <direction_type> – Direction of the port: o OUT – Output ▪ <port_format> – Type of signal on the port: o HDMI o ANALOG_AUDIO ▪ <port_index> – The port number as printed on the front or rear panel:1 ▪ <signal_type> – Signal ID attribute: o AUDIO ▪ <index> – Indicates a specific channel number when there are multiple channels of the same type audio_level – Audio level (range between 0 to +100) depending of the ability of the product	Set the output audio level to 10: #X-AUD-LVL_<out>.hdmi.1.audio.1,10<CR>
X-AUD-LVL?	Get audio level of a specific signal. ⓘ This is an Extended Protocol 3000 command.	COMMAND #X-AUD-LVL?_<direction_type>. <port_format>. <port_index>. <signal_type>. <index><CR> FEEDBACK ~nn@X-AUD-LVL_<direction_type>. <port_format>. <port_index>. <signal_type>. <index>,audio_level<CR><LF>	The following attributes comprise the signal ID: ▪ <direction_type> – Direction of the port: o OUT – Output ▪ <port_format> – Type of signal on the port: o HDMI o ANALOG_AUDIO ▪ <port_index> – The port number as printed on the front or rear panel:1 ▪ <signal_type> – Signal ID attribute: o AUDIO ▪ <index> – Indicates a specific channel number when there are multiple channels of the same type audio_level – Audio level (range between 0 to +100) depending of the ability of the product	Get the audio level of a specific signal: #X-AUD-LVL?_<out>.hdmi.1.audio.1<CR>
X-ROUTE	Send routing command to matrix. ⓘ It is recommended to use the command #SIGNALS-LIST to get the list of all signal IDs available in the system and which can be used in this command. Video 1 is the default port in this command and is implied even if not written: #X-ROUTE_<out>.sdi.5,in.sdi.1<CR> is interpreted as: #X-ROUTE_<out>.sdi.5.video.1,in.sdi.1.video.1<CR> This is an Extended Protocol 3000 command.	COMMAND #X-ROUTE_<direction_type>. <port_type>. <port_index1>. <signal_type>. <index1>, <direction_type2>. <port_type2>. <port_index2>. <signal_type2>. <index2><CR> FEEDBACK ~nn@X-ROUTE_<direction_type>. <port_type>. <port_index1>. <signal_type1>. <index1>, <direction_type2>. <port_type2>. <port_index2>. <signal_type2>. <index2><CR><LF>	The following attributes comprise the signal ID: ▪ <direction_type> – Direction of the port: o IN – Input o OUT – Output ▪ <port_format> – Type of signal on the port: o HDMI o HDBT ▪ <port_index> – The port number as printed on the front or rear panel: For inputs: 1–HDBT Input 2–HDMI Input For output: 1–HDMI Output ▪ <signal_type> – Signal ID attribute: o VIDEO ▪ <index> – Indicates a specific channel number when there are multiple channels of the same type: 1	Route HDBT IN to HDMI OUT: #X-ROUTE_<out>.hdmi.1.video.1,in.hdbt.1.video.1<CR>

Function	Description	Syntax	Parameters/Attributes	Example
X-ROUTE?	<p>Get routing status.</p> <p>i It is recommended to use the command #SIGNALS-LIST to get the list of all signal IDs available in the system and which can be used in this command.</p> <p>VIDEO.1 are the default <signal_type> and <index> in this command and are implied even if not written:</p> <p>#X-ROUTE_out.sdi.5,in.sdi.1<CR></p> <p>is interpreted as:</p> <p>#X-ROUTE_out.sdi.5.video.1,in.sdi.1.video.1<CR></p> <p>This is an Extended Protocol 3000 command.</p>	<p>COMMAND</p> <p>#X-ROUTE? <direction_type>. <port_type>. <port_index1>. <signal_type>. <index1><CR></p> <p>FEEDBACK</p> <p>~nnX-ROUTE <direction_type>. <port_type>. <port_index1>. <signal_type>. <index1>, <direction_type2>. <port_type2>. <port_index2>. <signal_type2>. <index2><CR><LF></p>	<p>The following attributes comprise the signal ID:</p> <ul style="list-style-type: none"> ▪ <direction_type> – Direction of the port: <ul style="list-style-type: none"> ○ IN – Input ○ OUT – Output ▪ <port_format> – Type of signal on the port: <ul style="list-style-type: none"> ○ HDMI ○ HDBT ▪ <port_index> – The port number as printed on the front or rear panel: <p>For inputs: 1–HDBT Input 2–HDMI Input</p> <p>For output: 1–HDMI Output</p> <ul style="list-style-type: none"> ▪ <signal_type> – Signal ID attribute: <ul style="list-style-type: none"> ○ VIDEO ▪ <index> – Indicates a specific channel number when there are multiple channels of the same type: 1 	<p>Get the routing status:</p> <p>#X-ROUTE?out.hdmi.1.video.1<CR></p>
X-SIGNAL?	<p>Get input signal status.</p> <p>i This is an Extended Protocol 3000 command.</p>	<p>COMMAND</p> <p>#X-SIGNAL? <direction_type>. <port_format>. <port_index>. <signal_type>. <index><CR></p> <p>FEEDBACK</p> <p>~nnX-SIGNAL <direction_type>. <port_format>. <port_index>. <signal_type>. <index>, status<CR><LF></p>	<p>The following attributes comprise the signal ID:</p> <ul style="list-style-type: none"> ▪ <direction_type> – Direction of the port: <ul style="list-style-type: none"> ○ IN – Input ▪ <port_format> – Type of signal on the port: <ul style="list-style-type: none"> ○ HDMI ○ HDBT ▪ <port_index> – The port number as printed on the front or rear panel: <ul style="list-style-type: none"> 1 – HDBT Input 2 – HDMI Input ▪ <signal_type> – Signal ID attribute: <ul style="list-style-type: none"> ○ VIDEO ▪ <index> – Indicates a specific channel number when there are multiple channels of the same type: 1 <p>status – Input Signal Status 0– No signal 1– There is a signal</p>	<p>Get the HDMI input signal status:</p> <p>#X-SIGNAL?in.hdmi.2.video.1<CR></p>

Result and Error Codes

Syntax

In case of an error, the device responds with an error message. The error message syntax:

- **~NN@ERR XXX<CR><LF>** – when general error, no specific command
- **~NN@CMD ERR XXX<CR><LF>** – for specific command
- **NN** – machine number of device, default = 01
- **XXX** – error code

Error Codes

Error Name	Error Code	Description
P3K_NO_ERROR	0	No error
ERR_PROTOCOL_SYNTAX	1	Protocol syntax
ERR_COMMAND_NOT_AVAILABLE	2	Command not available
ERR_PARAMETER_OUT_OF_RANGE	3	Parameter out of range
ERR_UNAUTHORIZED_ACCESS	4	Unauthorized access
ERR_INTERNAL_FW_ERROR	5	Internal FW error
ERR_BUSY	6	Protocol busy
ERR_WRONG_CRC	7	Wrong CRC
ERR_TIMEDOUT	8	Timeout
ERR_RESERVED	9	(Reserved)
ERR_FW_NOT_ENOUGH_SPACE	10	Not enough space for data (firmware, FPGA...)
ERR_FS_NOT_ENOUGH_SPACE	11	Not enough space – file system
ERR_FS_FILE_NOT_EXISTS	12	File does not exist
ERR_FS_FILE_CANT_CREATED	13	File can't be created
ERR_FS_FILE_CANT_OPEN	14	File can't open
ERR_FEATURE_NOT_SUPPORTED	15	Feature is not supported
ERR_RESERVED_2	16	(Reserved)
ERR_RESERVED_3	17	(Reserved)
ERR_RESERVED_4	18	(Reserved)
ERR_RESERVED_5	19	(Reserved)
ERR_RESERVED_6	20	(Reserved)
ERR_PACKET_CRC	21	Packet CRC error
ERR_PACKET_MISSED	22	Packet number isn't expected (missing packet)
ERR_PACKET_SIZE	23	Packet size is wrong
ERR_RESERVED_7	24	(Reserved)
ERR_RESERVED_8	25	(Reserved)
ERR_RESERVED_9	26	(Reserved)
ERR_RESERVED_10	27	(Reserved)
ERR_RESERVED_11	28	(Reserved)
ERR_RESERVED_12	29	(Reserved)
ERR_EDID_CORRUPTED	30	EDID corrupted
ERR_NON_LISTED	31	Device specific errors
ERR_SAME_CRC	32	File has the same CRC – not changed
ERR_WRONG_MODE	33	Wrong operation mode
ERR_NOT_CONFIGURED	34	Device/chip was not initialized

The warranty obligations of Kramer Electronics Inc. ("Kramer Electronics") for this product are limited to the terms set forth below:

What is Covered

This limited warranty covers defects in materials and workmanship in this product.

What is Not Covered

This limited warranty does not cover any damage, deterioration or malfunction resulting from any alteration, modification, improper or unreasonable use or maintenance, misuse, abuse, accident, neglect, exposure to excess moisture, fire, improper packing and shipping (such claims must be presented to the carrier), lightning, power surges, or other acts of nature. This limited warranty does not cover any damage, deterioration or malfunction resulting from the installation or removal of this product from any installation, any unauthorized tampering with this product, any repairs attempted by anyone unauthorized by Kramer Electronics to make such repairs, or any other cause which does not relate directly to a defect in materials and/or workmanship of this product. This limited warranty does not cover cartons, equipment enclosures, cables or accessories used in conjunction with this product.

Without limiting any other exclusion herein, Kramer Electronics does not warrant that the product covered hereby, including, without limitation, the technology and/or integrated circuit(s) included in the product, will not become obsolete or that such items are or will remain compatible with any other product or technology with which the product may be used.

How Long this Coverage Lasts

The standard limited warranty for Kramer products is seven (7) years from the date of original purchase, with the following exceptions:

1. All Kramer VIA hardware products are covered by a standard three (3) year warranty for the VIA hardware and a standard three (3) year warranty for firmware and software updates; all Kramer VIA accessories, adapters, tags, and dongles are covered by a standard one (1) year warranty.
2. Kramer fiber optic cables, adapter-size fiber optic extenders, pluggable optical modules, active cables, cable retractors, ring mounted adapters, portable power chargers, Kramer speakers, and Kramer touch panels are covered by a standard one (1) year warranty. Kramer 7-inch touch panels purchased on or after April 1st, 2020 are covered by a standard two (2) year warranty.
3. All Kramer Calibre products, all Kramer Minicom digital signage products, all HighSecLabs products, all streaming, and all wireless products are covered by a standard three (3) year warranty.
4. All Sierra Video MultiViewers are covered by a standard five (5) year warranty.
5. Sierra switchers & control panels are covered by a standard seven (7) year warranty (excluding power supplies and fans that are covered for three (3) years).
6. K-Touch software is covered by a standard one (1) year warranty for software updates.
7. All Kramer passive cables are covered by a lifetime warranty.

Who is Covered

Only the original purchaser of this product is covered under this limited warranty. This limited warranty is not transferable to subsequent purchasers or owners of this product.

What Kramer Electronics Will Do

Kramer Electronics will, at its sole option, provide one of the following three remedies to whatever extent it shall deem necessary to satisfy a proper claim under this limited warranty:

1. Elect to repair or facilitate the repair of any defective parts within a reasonable period of time, free of any charge for the necessary parts and labor to complete the repair and restore this product to its proper operating condition. Kramer Electronics will also pay the shipping costs necessary to return this product once the repair is complete.
2. Replace this product with a direct replacement or with a similar product deemed by Kramer Electronics to perform substantially the same function as the original product. If a direct or similar replacement product is supplied, the original product's end warranty date remains unchanged and is transferred to the replacement product.
3. Issue a refund of the original purchase price less depreciation to be determined based on the age of the product at the time remedy is sought under this limited warranty.

What Kramer Electronics Will Not Do Under This Limited Warranty

If this product is returned to Kramer Electronics or the authorized dealer from which it was purchased or any other party authorized to repair Kramer Electronics products, this product must be insured during shipment, with the insurance and shipping charges prepaid by you. If this product is returned uninsured, you assume all risks of loss or damage during shipment. Kramer Electronics will not be responsible for any costs related to the removal or re-installation of this product from or into any installation. Kramer Electronics will not be responsible for any costs related to any setting up this product, any adjustment of user controls or any programming required for a specific installation of this product.

How to Obtain a Remedy Under This Limited Warranty

To obtain a remedy under this limited warranty, you must contact either the authorized Kramer Electronics reseller from whom you purchased this product or the Kramer Electronics office nearest you. For a list of authorized Kramer Electronics resellers and/or Kramer Electronics authorized service providers, visit our web site at www.kramerav.com or contact the Kramer Electronics office nearest you.

In order to pursue any remedy under this limited warranty, you must possess an original, dated receipt as proof of purchase from an authorized Kramer Electronics reseller. If this product is returned under this limited warranty, a return authorization number, obtained from Kramer Electronics, will be required (RMA number).

You may also be directed to an authorized reseller or a person authorized by Kramer Electronics to repair the product.

If it is decided that this product should be returned directly to Kramer Electronics, this product should be properly packed, preferably in the original carton, for shipping. Cartons not bearing a return authorization number will be refused.

Limitation of Liability

THE MAXIMUM LIABILITY OF KRAMER ELECTRONICS UNDER THIS LIMITED WARRANTY SHALL NOT EXCEED THE ACTUAL PURCHASE PRICE PAID FOR THE PRODUCT. TO THE MAXIMUM EXTENT PERMITTED BY LAW, KRAMER ELECTRONICS IS NOT RESPONSIBLE FOR DIRECT, SPECIAL, INCIDENTAL OR CONSEQUENTIAL DAMAGES RESULTING FROM ANY BREACH OF WARRANTY OR CONDITION, OR UNDER ANY OTHER LEGAL THEORY. Some countries, districts or states do not allow the exclusion or limitation of relief, special, incidental, consequential or indirect damages, or the limitation of liability to specified amounts, so the above limitations or exclusions may not apply to you.

Exclusive Remedy

TO THE MAXIMUM EXTENT PERMITTED BY LAW, THIS LIMITED WARRANTY AND THE REMEDIES SET FORTH ABOVE ARE EXCLUSIVE AND IN LIEU OF ALL OTHER WARRANTIES, REMEDIES AND CONDITIONS, WHETHER ORAL OR WRITTEN, EXPRESS OR IMPLIED. TO THE MAXIMUM EXTENT PERMITTED BY LAW, KRAMER ELECTRONICS SPECIFICALLY DISCLAIMS ANY AND ALL IMPLIED WARRANTIES, INCLUDING, WITHOUT LIMITATION, WARRANTIES OF MERCHANTABILITY AND FITNESS FOR A PARTICULAR PURPOSE. IF KRAMER ELECTRONICS CANNOT LAWFULLY DISCLAIM OR EXCLUDE IMPLIED WARRANTIES UNDER APPLICABLE LAW, THEN ALL IMPLIED WARRANTIES COVERING THIS PRODUCT, INCLUDING WARRANTIES OF MERCHANTABILITY AND FITNESS FOR A PARTICULAR PURPOSE, SHALL APPLY TO THIS PRODUCT AS PROVIDED UNDER APPLICABLE LAW. IF ANY PRODUCT TO WHICH THIS LIMITED WARRANTY APPLIES IS A "CONSUMER PRODUCT" UNDER THE MAGNUSON-MOSS WARRANTY ACT (15 U.S.C.A. §2301, ET SEQ.) OR OTHER APPLICABLE LAW, THE FOREGOING DISCLAIMER OF IMPLIED WARRANTIES SHALL NOT APPLY TO YOU, AND ALL IMPLIED WARRANTIES ON THIS PRODUCT, INCLUDING WARRANTIES OF MERCHANTABILITY AND FITNESS FOR THE PARTICULAR PURPOSE, SHALL APPLY AS PROVIDED UNDER APPLICABLE LAW.

Other Conditions

This limited warranty gives you specific legal rights, and you may have other rights which vary from country to country or state to state.

This limited warranty is void if (i) the label bearing the serial number of this product has been removed or defaced, (ii) the product is not distributed by Kramer Electronics or (iii) this product is not purchased from an authorized Kramer Electronics reseller. If you are unsure whether a reseller is an authorized Kramer Electronics reseller, visit our web site at www.kramerav.com or contact a Kramer Electronics office from the list at the end of this document.

Your rights under this limited warranty are not diminished if you do not complete and return the product registration form or complete and submit the online product registration form. Kramer Electronics thanks you for purchasing a Kramer Electronics product. We hope it will give you years of satisfaction.



SAFETY WARNING

Disconnect the unit from the power supply before opening and servicing

For the latest information on our products and a list of Kramer distributors, visit our website where updates to this user manual may be found.

We welcome your questions, comments, and feedback.

The terms HDMI, HDMI High-Definition Multimedia Interface, and the HDMI Logo are trademarks or registered trademarks of HDMI Licensing Administrator, Inc. All brand names, product names, and trademarks are the property of their respective owners.